



RUGGED WATER RESISTANT
INVERTER / CHARGER

OBX-IC2024S-120/60

Owner's Manual

Installation and Operation

OutBack Power Systems

OutBack Power Systems is a leader in advanced energy conversion technology. Our products include true sine wave inverter/chargers, maximum power point charge controllers, system communication components, as well as breaker panels, breakers, accessories, and assembled systems.

Contact Information

Telephone: (+1) 360.435.6030 (North America) Fax: (+1) 360.435.6019
 (+34) 93.654.9568 (Barcelona, Spain)

Address: North America
 19009 62nd Avenue NE
 Arlington, WA USA

E-mail: Support@OutbackPower.com

Web: www.OutBackPower.com

Disclaimer

UNLESS SPECIFICALLY AGREED TO IN WRITING, OUTBACK POWER SYSTEMS:

(a) MAKES NO WARRANTY AS TO THE ACCURACY, SUFFICIENCY OR SUITABILITY OF ANY TECHNICAL OR OTHER INFORMATION PROVIDED IN ITS MANUALS OR OTHER DOCUMENTATION.

(b) ASSUMES NO RESPONSIBILITY OR LIABILITY FOR LOSS OR DAMAGE, WHETHER DIRECT, INDIRECT, CONSEQUENTIAL OR INCIDENTAL, WHICH MIGHT ARISE OUT OF THE USE OF SUCH INFORMATION. THE USE OF ANY SUCH INFORMATION WILL BE ENTIRELY AT THE USER'S RISK.

Warranty Summary

OutBack Power Systems Inc. warrants that the products it manufactures will be free from defects in materials and workmanship for a period of one (1) year subject to the conditions set forth in the warranty detail found inside the back cover of this manual.

OutBack Power Systems cannot be responsible for system failure, damages, or injury resulting from improper installation of their products.

Notice of Copyright

User Manual, OutBack Extreme Rugged Water Resistant Inverter/Charger

©July 2009 by OutBack Power Systems. All Rights Reserved.

Trademarks

OutBack Power is a registered trademark of OutBack Power Systems.

Date and Revision

July 2009, Revision A

TABLE OF CONTENTS

Welcome to the OutBack Extreme Rugged Water Resistant Inverter/Charger	2
Parts Included.....	3
Unit Dimensions.....	3
Required Conductors.....	3
Environmental Concerns	3
Inverter Maintenance.....	3
Storage	3
Safety Instructions.....	4
Initial Inspection.....	4
Use and Storage.....	4
Battery Safety Instructions.....	5
Mounting.....	6
System Protection.....	7
Grounding Requirements.....	7
DC Wiring.....	8
Battery Wiring	9
AC Wiring	12
MATE2 System Controller and Display	15
Hot Keys.....	16
Soft Keys.....	19
Summary Screens.....	19
Setup Screens.....	20
Summary Setup Screens.....	21
Communication Setup Screens.....	23
Status Screens.....	25
Status Meter Screens.....	27
Status Batt(ery) Screens.....	28
Status Error Screens.....	29
Status Warn(ing) Screens.....	30
Status Disconnect Screens.....	31
Installation Drawing.....	32
Installation Check List.....	33
OBX-IC2024S-120/60 Inverter/Charger Specifications.....	34
OBX-IC2024S-120/60 Inverter/Charger Default Values.....	37
Maintenance.....	38
Troubleshooting.....	38
Warranty.....	39
Product Registration.....	41

Welcome to the OutBack Extreme Rugged Water Resistant Inverter/Charger

The OutBack Extreme Rugged Water Resistant Inverter/Charger (hereafter called the Inverter) provides 120 Vac, 60 Hz, true-sine wave power, from a 24 Vdc battery source. It is designed for rugged operational environments in an unprotected, uncontrolled climate. This equipment is intended for use on tracked and wheeled vehicles, and above deck and other areas where it will be exposed to unfavorable conditions.

OutBack Power Systems does everything possible to assure the components you purchase will function properly and safely when installed as instructed according to local and national electrical codes. Please read all of the following instructions and the instructions that come with any other OutBack components that make up your power system. Further instructions on individual Inverter setups as well as systems assemblies are included with the FLEXware manuals.

This Owner's Manual covers the following information:

- Safety
- Inverter parts, standard and optional
- Initial inspection of the component
- Preparing the mounting surface
- Fastening the Inverter to the mounting surface
- General electrical information
- Installing and programming the MATE2 System Controller and Display (hereafter called the MATE)

OutBack Extreme Rugged Water Resistant Inverter/Charger

- Part Number OBX-IC2024S-120/60
- 2000VA/24VDC
- 120VAC/60Hz
- 30 amp AC transfer switch with neutral-ground bond switching
- Environmentally protected unit

Each Inverter has a single phase output marked with this symbol: 

Each Inverter puts out a sine wave waveform marked with this symbol: 

Parts Included

Standard with the OutBack Extreme Rugged Water Resistant Inverter/Charger, Model **OBX-IC2024S-120/60**:

- One Owner's Manual
- One DC Cover (DCC)
- One red (positive) and one black (negative) battery terminal cap

Additional parts, included when purchasing the complete system **OBX-IC2024S-120/60-K2**:

- One OutBack MATE2 System Controller and Display
- One NATO Battery Cable Connector, unwired
- Two 2/0 battery cables (one positive and one negative), 15'
- One Maxicon cable assembly for watertight AC input connections, 6'
- One Maxicon cable assembly for watertight AC output connections, 6'
- One Minicon cable assembly for watertight communications connections, 6'

Additional replacement system parts:

- NATO Battery Cable Assembly, 15', part number **OBX-CABLE500-180-NATO**

NOTE: Due to the variety of installation options available, mounting hardware is not included. All fasteners must be adequate to support the weight of the Inverter. No fewer than four fasteners, one per corner, should be used for a safe installation.

Unit Dimensions

- 8.25" x 16.25" x 12" (20.95 cm x 41.27 cm x 30.48 cm)
- 57.5 lbs (26.08 kg)

Required Conductors

Installations should be performed using the cables provided with the unit.

If it should become necessary to use replacement cables, the replacements **MUST** meet the following minimum specifications:

- Use 2/0 AWG (0.3648" or 9.26 mm), 4/0 AWG (0.4600" or 11.7 mm), or larger approved cables rated 75° C or higher for DC wiring.
- Use #10 AWG (0.1019" or 2.60 mm) or larger approved cables rated 75° C or higher for AC wiring.

Environmental Concerns

In the event the Inverter needs to be disposed of, its aluminum casing is easily recyclable as are any stripped-out internal metal and plastic parts. All circuit boards and electronic components should be disposed or recycled in accordance with local environmental laws.

Inverter Maintenance

- Following exposure to salt water, rinse all exposed surfaces to prevent corrosion. Recoat the DC lugs and other exposed conductors with dielectric grease.
- Periodically check that the battery cable lugs are tight and secure, using recommended torque settings.
- Brush off excessive dust from the Inverter as needed.
- Check that all fasteners are tight.
- If the Inverter is not operating:
 - Use a meter to verify the DC battery voltage at the Inverter terminals.
 - Measure and verify the AC current at the Inverter output terminals.
 - Swap the MATE or cable with another, particularly if the unit works and the MATE does not.
 - Call OutBack Technical Support for further assistance or repairs. Being heavily sealed, the Inverter is not user-serviceable.

Contact OutBack Technical Support at (360) 618-4363 or support@outbackpower.com.
(Please see the warranty section of this manual for more service information.)

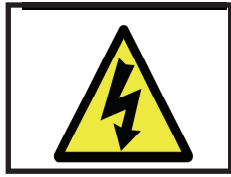

IMPORTANT SAFETY INSTRUCTIONS

READ FIRST!

SAVE THESE INSTRUCTIONS

Read all instructions and cautionary markings on the Inverter, the batteries and all appropriate sections of this installation and user manual as well as other component manuals before using the system.

Be cautious around electricity, electrical components, and batteries. Shocks, burns, injury, and even death can occur if anyone comes in contact with electricity.

Install all components and wiring according to any appropriate regulations. OutBack Power Systems cannot be responsible for system failure, damages, or injury resulting from improper installation of their products.

Install the Inverter in a well-ventilated, area out of direct sunlight, preferably indoors, for best operation.

Use only the DC and AC cables provided. Be sure all wires are in good condition.

Ensure the DC negative and chassis ground are bonded together in one place, and only one place. Ensure the AC neutral and chassis ground are bonded together in one place, and only one place.

(See page 7 for more information.)

Initial Inspection

Your Inverter is stoutly packaged for secure shipping. Please inspect the packaging and component for damage or exposure to water prior to installation. Never power up a damaged Inverter.

Use and Storage

The Inverter is designed to be exposed to wet or inclement conditions. However, it is not intended to be energized or used while submerged. If the operating platform is submerged, the recommended practice is to wait five minutes after emergence before powering up the Inverter. The unit can be used any time after the initial 5 minutes.

The MATE2 System Controller and Display is not water-resistant and is not designed to be exposed to wet or inclement conditions. If necessary, the MATE can be removed from the system while these conditions apply, or while not in use. The Inverter has non-volatile memory and will keep all its settings.

The recommended practice for storage is for each Inverter to be kept in a cool, dry area.

IMPORTANT BATTERY INSTRUCTIONS

WARNING: WORKING NEAR LEAD ACID BATTERIES CAN BE DANGEROUS. BATTERIES GENERATE EXPLOSIVE GASES DURING NORMAL OPERATION.

Design the battery enclosure to prevent accumulation and concentration of hydrogen gas in “pockets” at the top of the enclosure. Vent the battery compartment from the highest point to the outside. A sloped lid can also be used to direct the flow of hydrogen to the vent opening.

CAUTION

To reduce risk of injury, charge only deep-cycle lead acid, lead antimony, lead calcium, gel cell or absorbed glass mat type rechargeable batteries. Other types of batteries may burst, causing personal injury and damage. Never charge a frozen battery.

SAFETY AND HUMAN FACTORS

- Someone should be within range of your voice to come to your aid if needed.
- Keep plenty of fresh water and soap nearby in case battery acid contacts skin, clothing, or eyes.
- Wear complete eye protection. Avoid touching eyes while working near batteries. Wash your hands with soap and warm water when done.
- If battery acid contacts skin or clothing, wash immediately with soap and water. If acid enters an eye, flood the eye with cool running water at once for at least 15 minutes and get medical attention immediately following.
- Baking soda neutralizes lead acid battery electrolyte. Keep a supply on hand in the battery area.
- NEVER smoke or allow a spark or flame in vicinity of a battery or generator.
- Do not contact battery lugs or ring terminals with your skin; this increases the risk of a shock.
- Be extra cautious to reduce the risk of dropping a metal tool onto batteries. It could short-circuit the batteries or other electrical parts and can result in fire or explosion.
- Remove personal metal items such as rings, bracelets, necklaces, and watches when working with a battery or other electrical current. A battery can produce a short circuit current high enough to weld a ring or the like to metal, causing severe burns.

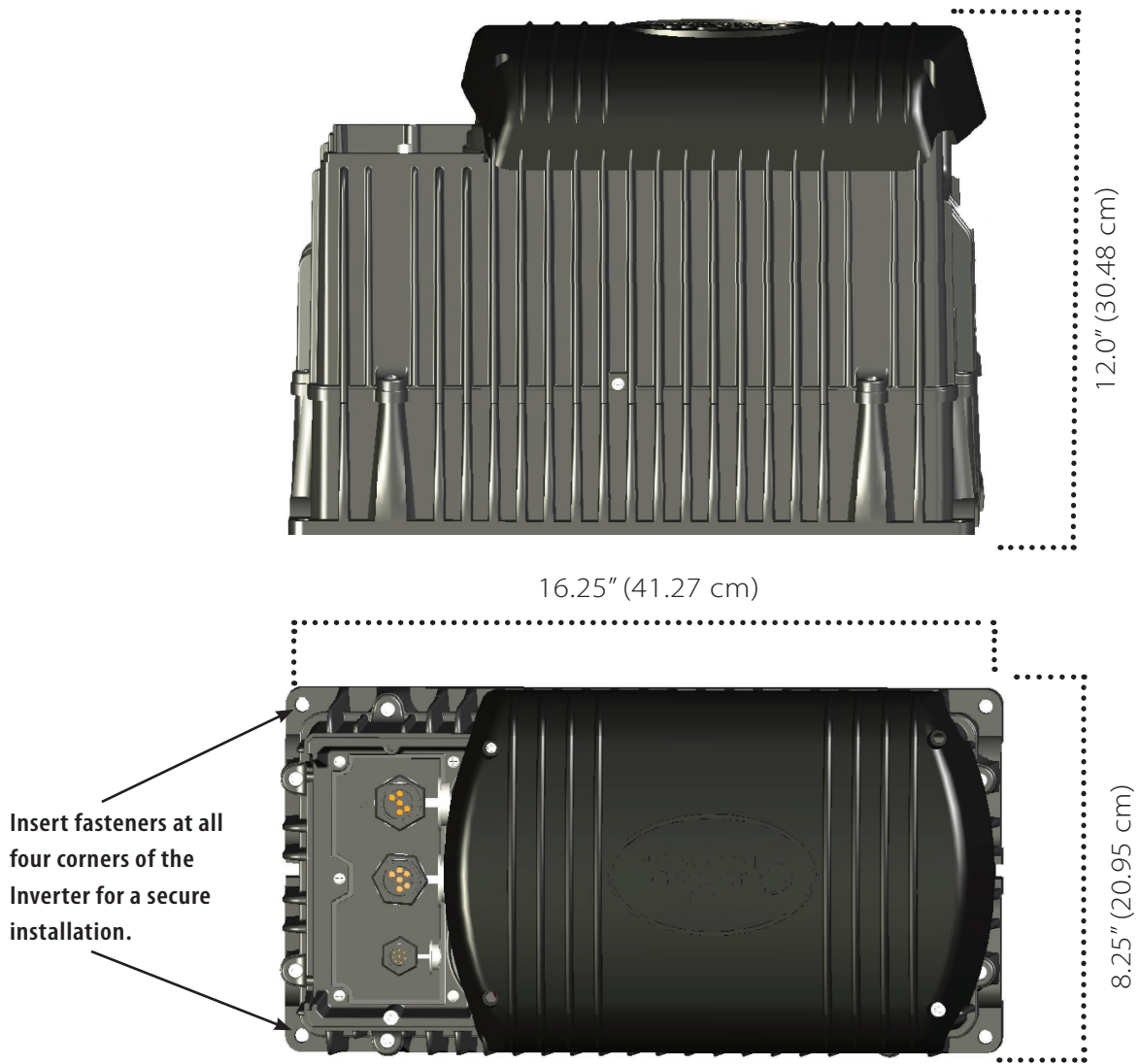

MOUNTING

- The Inverter weighs 57.5 lbs (26.08 kg) and must be secured with appropriate fasteners to a sturdy mounting surface capable of supporting its weight. Depending on application, it may be easier for two people to install the unit due to the Inverter's weight.
- If internally mounted (protected from the environment), the Inverter can be mounted in any position or orientation. If externally mounted (exposed to the environment), the Inverter cannot be mounted upside-down, to ensure that water will not stand under the DC cover. (It can be mounted in any other position or orientation.) In all cases, the Inverter will perform better in locations offering plenty of air circulation.
- When mounting the Inverter on a given surface, use appropriate fasteners to support its weight. OutBack cannot be responsible for damage to the Inverter if it is attached with inadequate fasteners.
- Install and secure each Inverter before attaching any wiring.
- If mounted on a tracked or other non-suspension-type profile, consideration should be made to use shock dampening technology between the platform and the Inverter chassis due to the potential vibration and other mechanical energy transfer.

SYSTEM PROTECTION

Electrical systems are designed to protect you, the wires, the components, and the devices served by the system.

- Each Inverter must be part of a permanently grounded electrical system (see below). Grounding protects people and equipment from electrical shock. Grounding must be performed according to required codes and regulations.
- Circuit breakers protect wiring by limiting the amount of current entering a system. All wired electrical systems require circuit breakers or fuses for protection. See following pages for sizing.
- OutBack Power Systems offers both breakers and fuses for overcurrent protection. If they are provided by other vendors, they must be properly rated.

AC AND DC GROUNDING REQUIREMENTS

- Connect only to a grounded, permanent wiring system. Use the box lug on top of the Inverter.
- For all installations, the negative battery conductor should be bonded to the grounding system at one (and only one) point in the system.
- The Inverter should never be positive-grounded or used in a positive-ground installation. (In other words, never connect battery positive to ground).
- For all installations, the AC neutral wire must be connected to the chassis ground at one (and only one) point in the system.
- If the installation has no connection between neutral and ground, the Inverter has an internal switch which provides the bond when no other source is present. When a generator is used with the Inverter under these conditions, the generator's neutral and ground wires must also be bonded together, so that its bond protects the system when the generator is running. The neutral wires on the Inverter's input and output plugs must be electrically isolated from each other.
- If the load panel on the Inverter's output has neutral and ground bonded together, you should disable the Inverter's automatic bond switching. (Instructions for this are on page 13.) Under these conditions, the generator's neutral and ground should NOT be bonded together. The Inverter's input and output neutral wires can be electrically common.
- Failing to establish a neutral-ground bond is a safety hazard. Establishing more than one bond can result in nuisance tripping of GFCIs, and is also a safety hazard.

The equipment ground on each is marked with this symbol: 

Box lug for grounding the
Inverter chassis

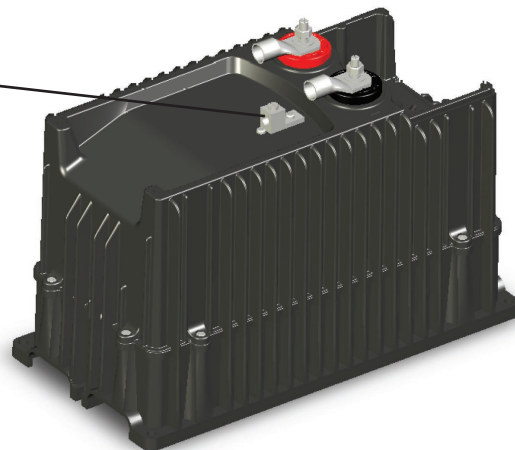

WIRE CONNECTIONS

DC Wiring

The Inverter uses DC brass battery terminals with 8M x 1.00 stainless steel threaded studs. You can access the terminals by removing the four screws that attach the DC cover plate, and pulling it off.

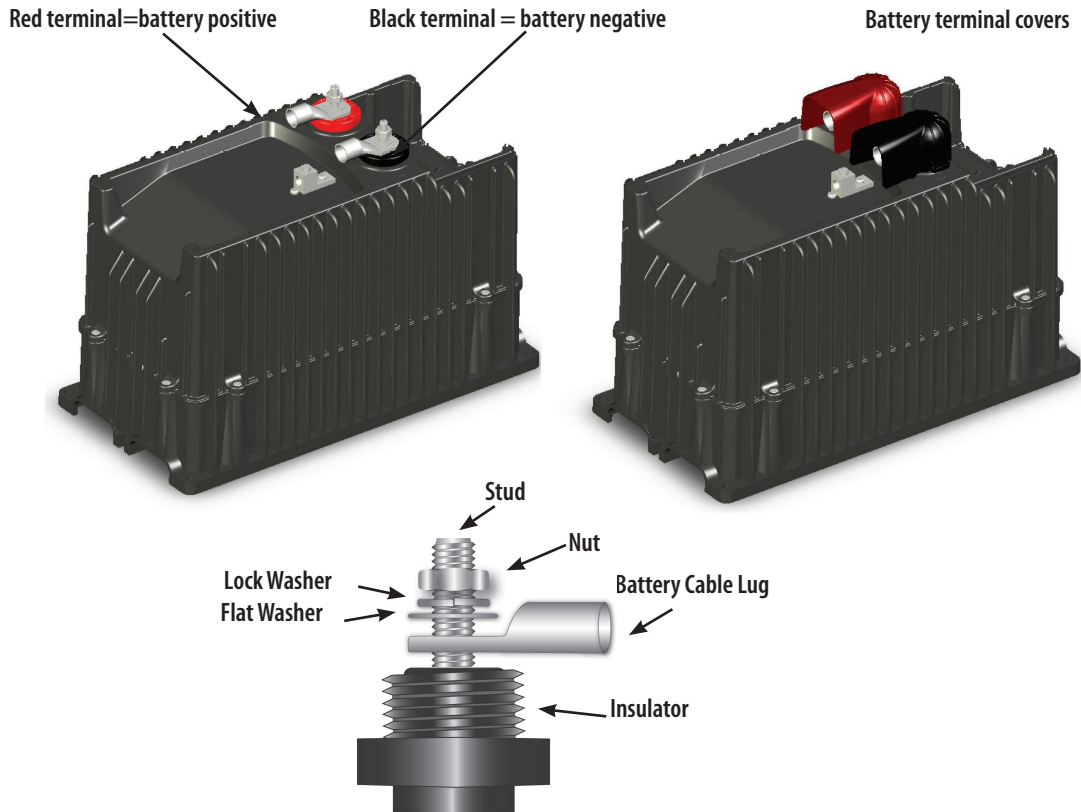

- Never install extra washers or any other hardware between the terminal mounting surface and the battery cable lug—the connection must be direct and secure.
- For the Inverter model OBX-IC2024S-120/60, a 175-amp DC breaker is recommended. If a DC fuse is used, it should be a Class T fuse and must not exceed a rating of 300 amps.
- Always install breakers or fuses on the positive battery cable.
- It is recommended to twist the positive and negative conductors around each other during installation. This is to reduce EMI (electromagnetic interference) emissions.
- Use torque values from the chart below for tightening battery connections and Inverter DC connections.

Connection	Torque
DC Battery Connections	to 10 foot-lbs/13.6 Nm
Inverter's DC terminals	to 5 foot-lbs/5.8 Nm

Battery Terminal Covers

- The caps are made of stiff plastic with a snap-on design; remove them carefully using a flat-blade screwdriver inserted into the slots on the sides of each cover.
- Always keep the battery terminal covers installed.

BATTERY WIRING

In DC systems, batteries are connected to each other in one of three ways:

- Series (voltage increases, amperage stays the same as a single battery)
- Parallel (voltage stays the same as a single battery, amperage increases)
- Series/Parallel (both voltage and amperage increase)

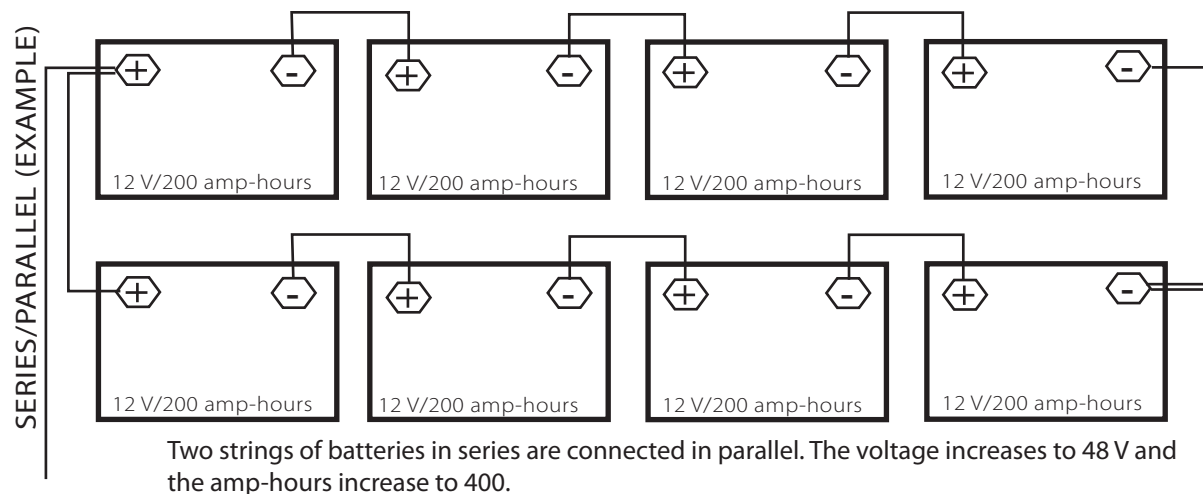
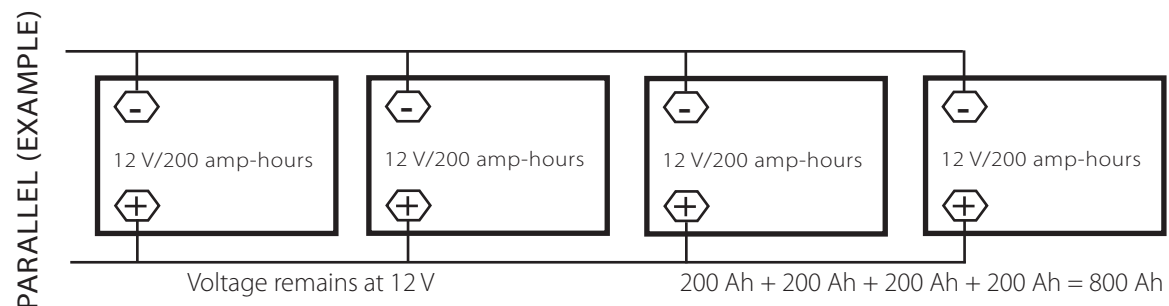
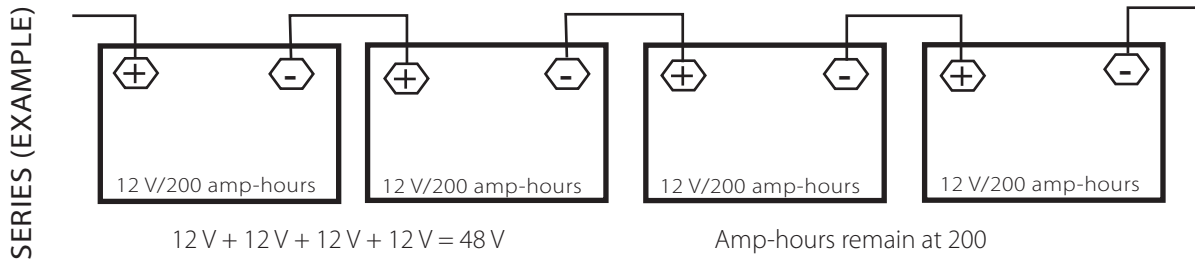

Since the OBX-IC2024S-120/60 is a 24-volt inverter, any series or parallel battery connections must be made for a 24-volt system. Methods for doing this will vary with battery type. Some examples are shown on the following pages.

6 V Battery Wiring Examples for a 24-volt system

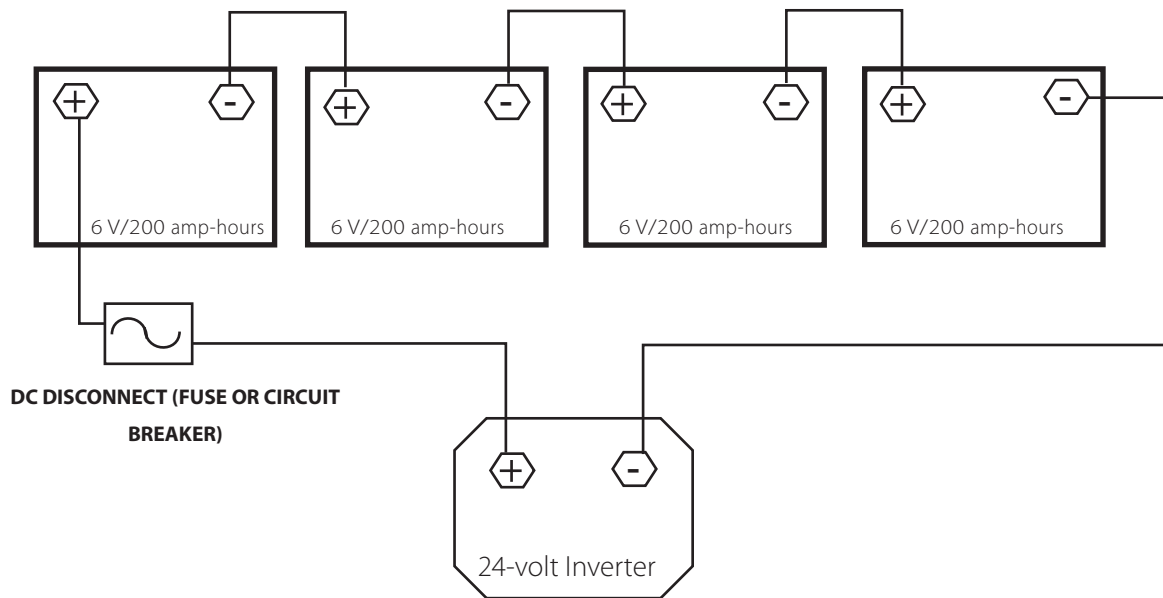

SERIES: 200 amp-hours

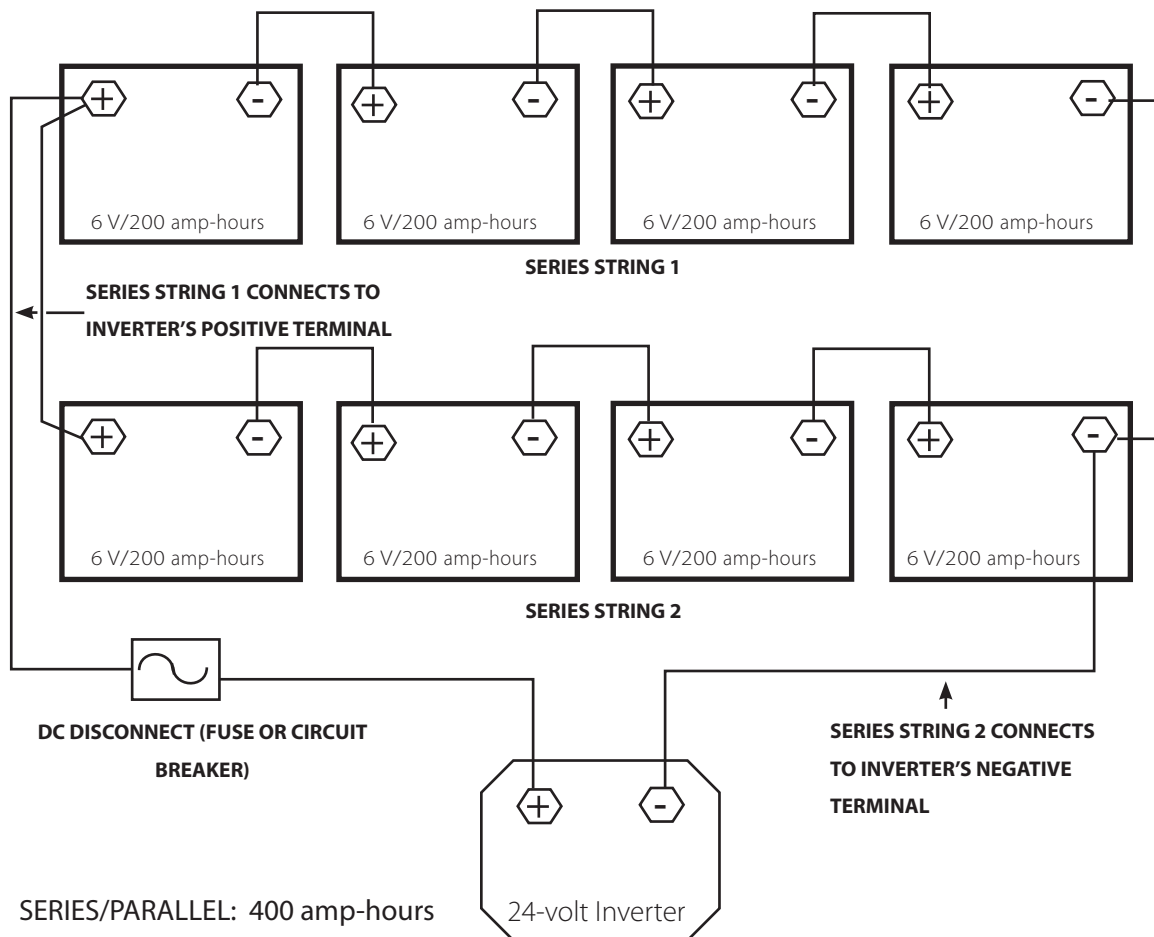

SERIES/PARALLEL: 400 amp-hours

12 V Battery Wiring Examples for a 24-volt system

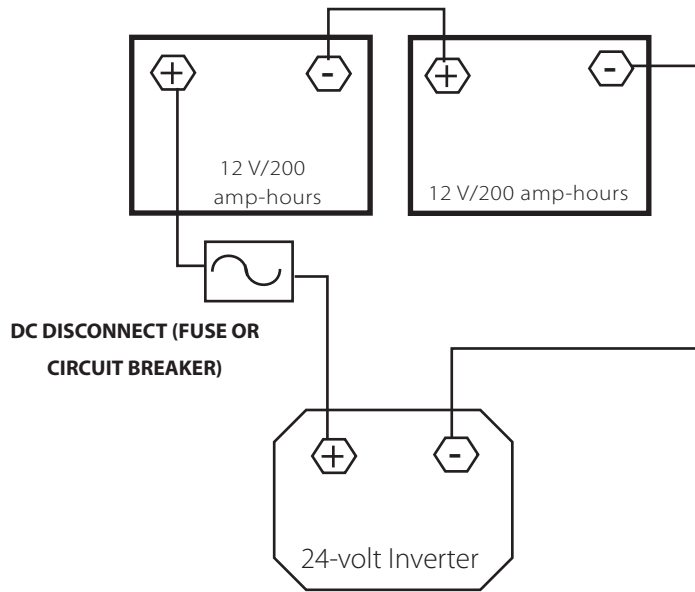

SERIES: 200 amp-hours

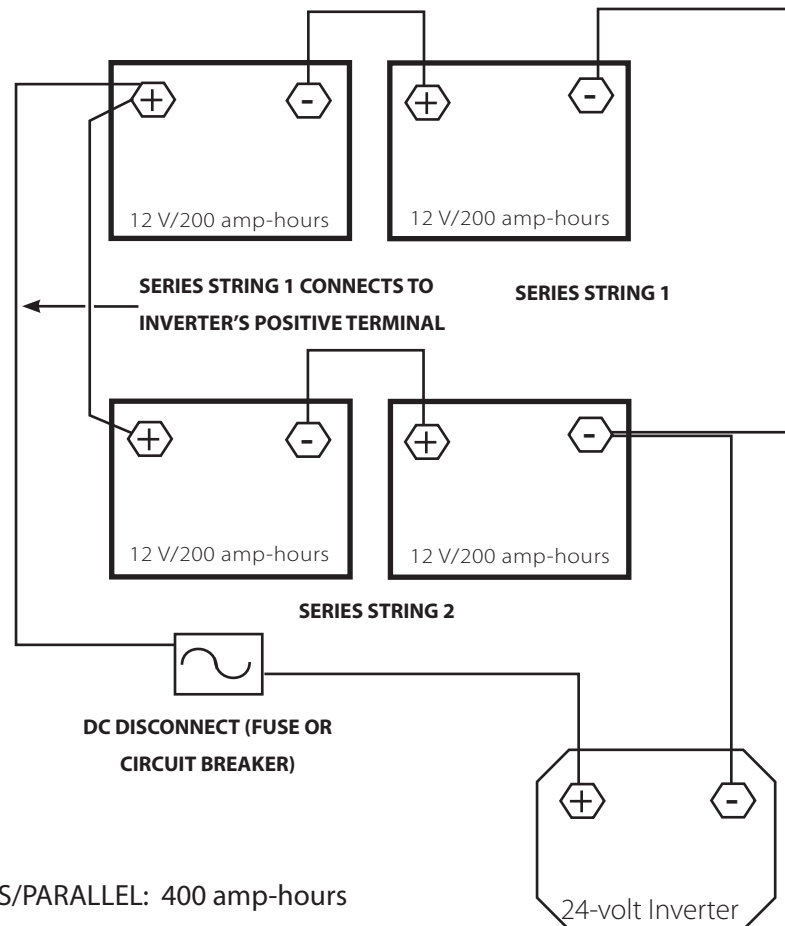

SERIES/PARALLEL: 400 amp-hours

AC Wiring

Connector Plate

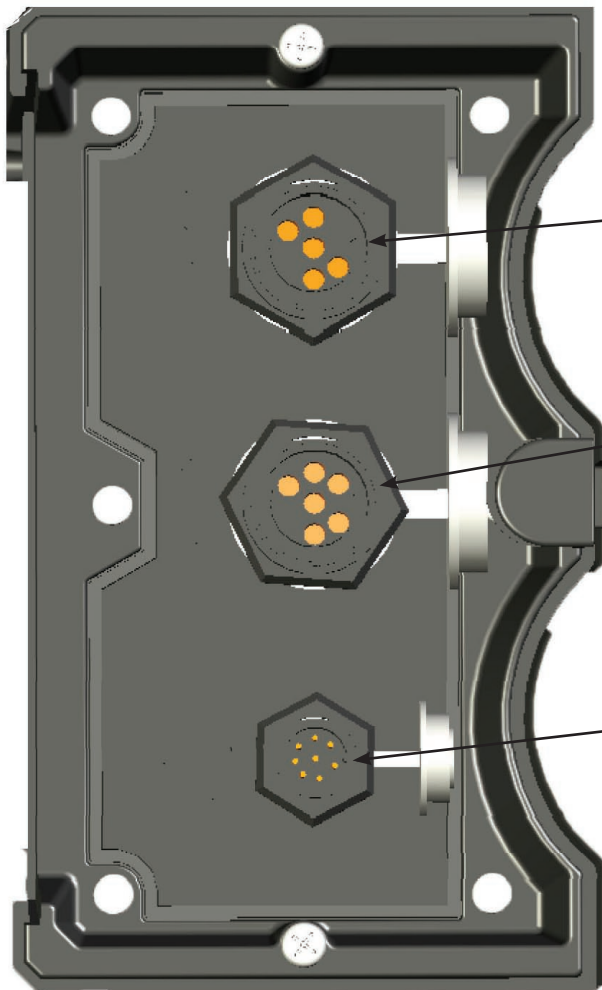
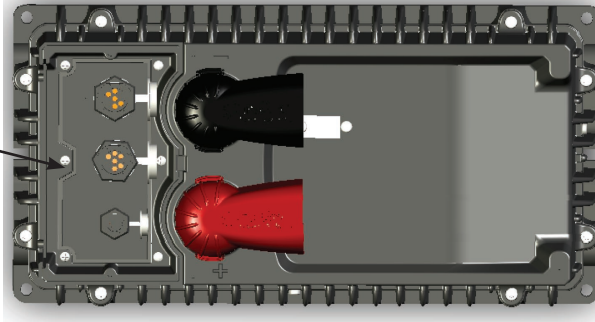

- **AC OUT SOCKET**— Maxicon circular molded watertight connector supplies power to the loads using the provided AC cable and plug.
- **AC IN SOCKET** — Maxicon circular molded watertight connector supplies incoming AC from the grid or a generator to the Inverter. This AC is used to run loads and recharge batteries.
- **MATE (REMOTE) SOCKET** — Minicon circular molded watertight connector provides an interface with the optional MATE2 System Controller and Display. When installed, the MATE provides meter readings, status messages, and error codes.

Follow these steps to wire the Inverter to your system:

1. Open all DC breakers or remove any fuses before connecting wiring.
2. Open all AC breakers or remove any fuses before connecting wiring.
3. With all power off, connect the AC IN Maxicon plug wires to the AC source. The AC input wires should have a (maximum) 30-amp AC breaker to provide overcurrent protection. The AC IN Maxicon plug has a total of six conductors. Two are black, two are white, one is green, and one is green with a yellow stripe.
 - The black wires in the AC IN plug are electrically common in the Inverter. (The wires are doubled for increased ampacity.) Connect both black wires to the hot line from the input source.
 - The white wires in the AC IN plug are also electrically common in the Inverter, and are also doubled for increased ampacity. Connect both white wires to the neutral line from the input source.
 - The single green wire is the AC ground to the chassis. Connect the green wire to the input source ground.
 - The single green wire with a yellow stripe establishes the Inverter's switched connection between neutral and ground. Connect the green/yellow wires to the input source ground if the installation's load panel does not have a neutral-ground bond of its own.

NOTE: *If the load panel has a neutral-ground bond that may not be removed, you must disable the Inverter's bond-switching function by removing the connection to the green/yellow wire. Under these conditions, this wire should be capped off and not connected to anything.*

4. With all power off, connect the AC OUT Maxicon plug wires to the AC source. The AC output wires should have a (maximum) 30-amp AC breaker to provide overcurrent protection. The AC OUT Maxicon plug has a total of five conductors. Two are black, two are white, and one is green.
 - The black wires in the AC OUT plug are electrically common in the Inverter. (The wires are doubled for increased ampacity.) Connect both black wires to the breaker, or to the hot connection on the load panel.
 - The white wires in the AC OUT plug are also electrically common in the Inverter, and are also doubled for increased ampacity. Connect both white wires to the neutral bus on the load panel.
 - The single green wire is the AC ground to the chassis. Connect the green wire to the load panel chassis ground.
5. If the system is equipped with a MATE, plug the RJ45 connector into the jack on the MATE itself.

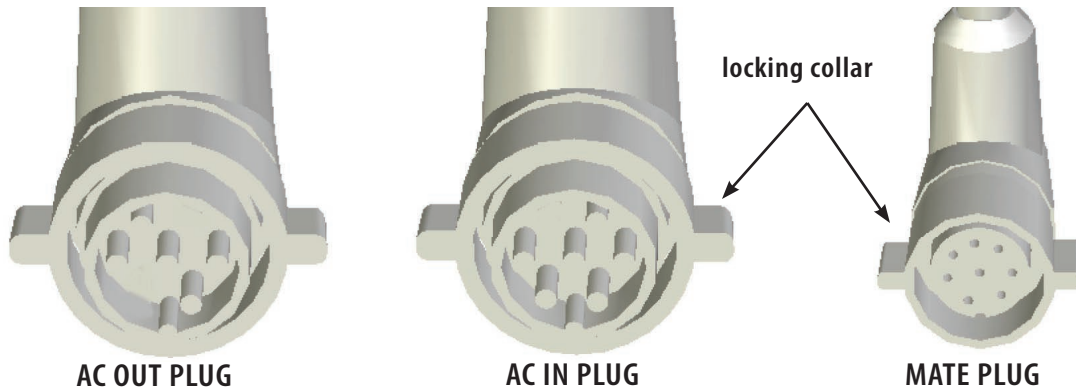

To connect cables to the Connector Plate sockets:

Position each cable plug over the appropriate jack. The cables are easy to tell apart, as the AC In plug has six pins, the AC Out plug only has five, and the MATE plug is smaller than the others.

Match each cable to its matching jack and fit the plugs into the jacks. If necessary, twist the plugs back and forth until they fit, and then push them in until they seat in place. (The plugs are keyed to fit only one way into the jacks, so they cannot be plugged in the wrong way.)

Once each plug is seated, turn the locking collar clockwise a quarter-turn until you feel the plug lock into place.

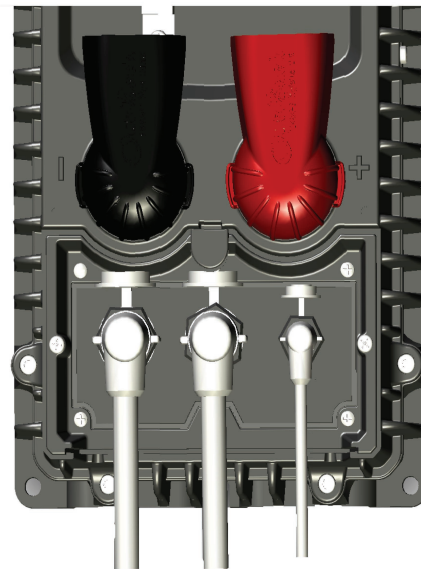
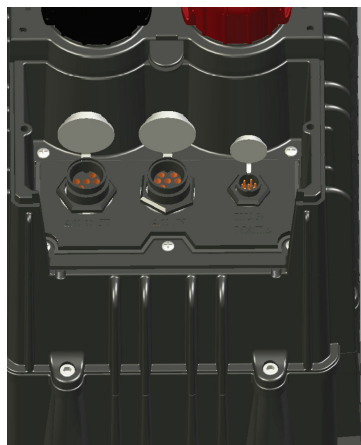

POWERING UP

Once all connections are established, it is safe to turn the power on, in the following order:

- Connect DC power, by closing the DC breaker or connecting the fuse. The MATE will power up. **The Inverter will energize and begin delivering 120 volts to the output immediately.** (The on/off function is controlled by the MATE. See the next section.)
- Connect the load panel by turning on the main AC breaker. Measure voltage at the disconnect to ensure that the Inverter is operating. Once this is confirmed, you should be able to run loads immediately.
- If an AC source is present, connect it by turning on the main AC input breaker. After a short delay, the Inverter will begin charging the battery.

THE MATE2 SYSTEM CONTROLLER AND DISPLAY

The MATE serves several functions:

- Allows you to monitor the Inverter through a series of convenient display screens. These display the status messages, and allow you to take both DC (voltage) and AC (voltage and current) meter readings.
- Enables you to troubleshoot problems with the Inverter and the rest of your system, by looking up warning and fault messages.
- The MATE allows a user to view, monitor, and establish all the pertinent settings and values that occur while the system is running. From time to time, these settings and values might be adjusted as components are added or upgraded, electrical loads increase, or patterns of usage change. Making these adjustments using the MATE is similar to adjusting any number of electronic devices we use every day. An example is a clock-radio with wake-up time and stations which are pre-set, but which can be customized.

The MATE displays two kinds of screens:

- Screens pertinent to the MATE's own functions, such as its clock and display.
- Inverter function screens (often labeled "FX" screens, after the parent product), which deal with its inverting and charging processes.

MATE AT A GLANCE

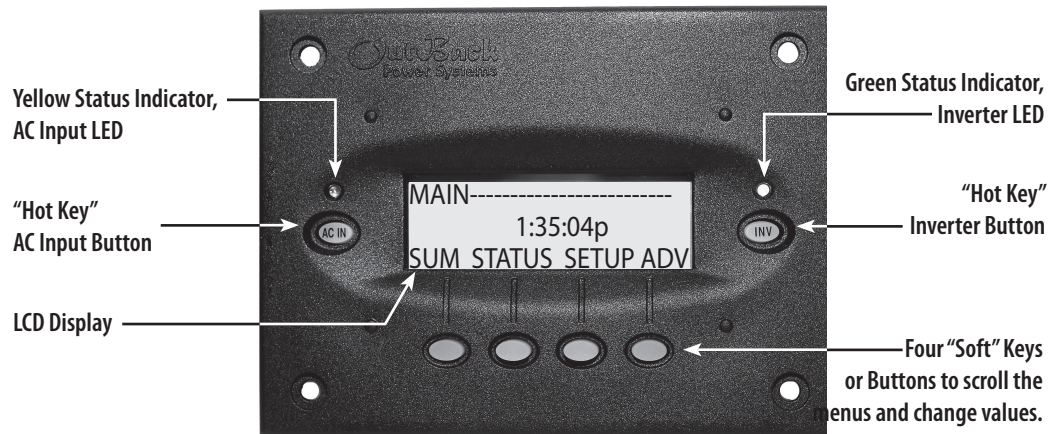

NOTE: Readability of the display is affected by direct sunlight.

Mounting the MATE:

Designed for surface mounting in an indoor location, just below the eye level of a typical user. The MATE's back cover can be unsnapped and attached directly to the surface. The cover requires four drywall screws or other fasteners to secure it. The MATE is then snapped back onto the mounted back cover.

HOT KEYS

“Hot” keys have fixed functions. Pressing a hot key always takes you to the same menu or series of menus.

INV Hot Key

The INV hot key takes you to the Inverter Control screen, allowing direct control of the inverting function from anywhere in the menu system. (The inverting function is defined as the process of converting DC to AC, as compared to the charging or other functions.)

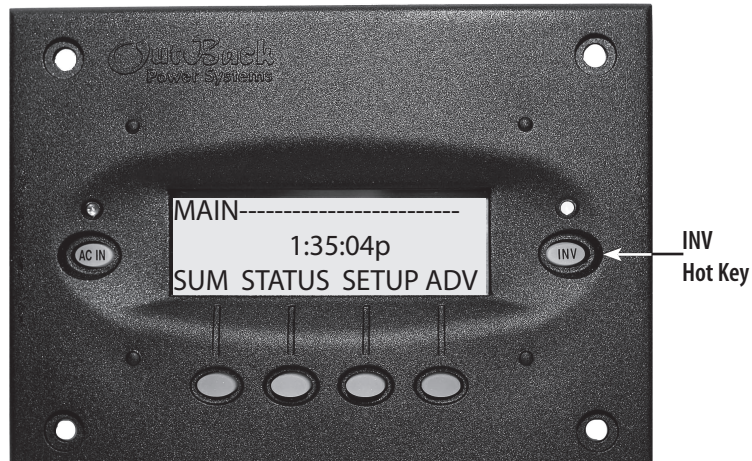

The green LED indicator above the INV has three modes:

- Flashing—the Inverter is either in the search or power save modes
- Continuously On—DC battery power is converted to AC power and the Inverter is supplying loads
- Off—the Inverter is not converting DC power to AC power, or else the AC input source is powering the loads

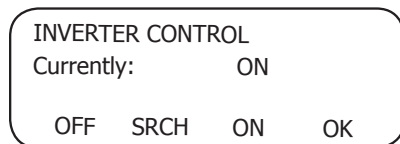

PRESS ONCE: **INV**

- The INVERTER CONTROL screen is called up, allowing the user to turn the inverting function ON or OFF.

<**OFF**> —turns off all Inverters connected to the MATE

<**SRCH**> —the Inverter begins search mode if the AC load connected is smaller than allowed by the programming of the search function. This function is not normally required to be used with the OBX-IC2024S-120/60 Inverter.

<**ON**> —turns on all Inverters connected to the MATE.

<**OK**> —returns to the point in the menu system where you entered the INVERTER CONTROL screen.

AC IN Hot Key

The AC IN hot key allows direct control of the AC input from anywhere in the menu system.



The yellow LED indicator above the AC IN “hot” key has three modes:

- *Flashing* - an AC source is available, but not connected
- *Continuously On* - the AC source is connected and in use (unit stops inverting during this time)
- *Off* - no AC source is present

Multiple AC IN keypresses will call up different AC and charging-related menus..

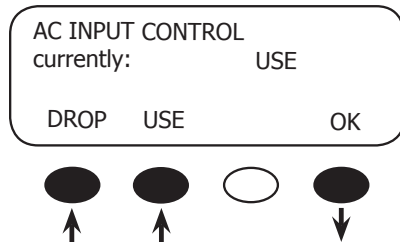

PRESS ONCE:

- The AC INPUT CONTROL screen is called up, allowing the user to connect or disconnect the Inverter to an AC input source.

<**USE**> enables the Inverter to connect to an AC input source.

<**DROP**> disconnects the AC input source but will allow it to be reconnected if the “low battery cut-off set point” occurs or the Inverter is overloaded.

<**OK**> returns to the point in the menu system before the user entered the AC INPUT CONTROL menu cycle.

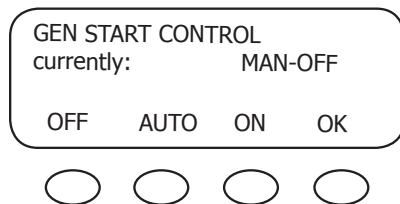

PRESS TWICE:

- The GEN START CONTROL screen allows changes to the Automatic Generator Start (AGS) mode, which is used with some models of FX inverter.



NOTE: *The AGS mode cannot be used with the OBX-IC2024S-120/60 Inverter.*

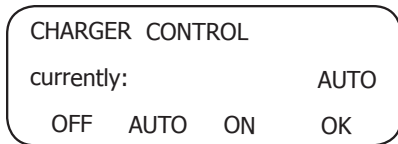

PRESS THREE TIMES: (AC IN) (AC IN) (AC IN)

- The CHARGER CONTROL screen appears. This allows the operation of the Inverter's battery charger to be preset for an available AC source.

<OFF> disables all charger functions in the Inverter.

<AUTO> enables automatic battery charging, silent, and "re-float" when an AC input source is connected.

<ON> also recharges the batteries, but eventually remains in the "float" charging stage (and eliminates silent mode) until the AC input is disconnected.

<OK> returns to the point in the menu system where you entered the AC INPUT CONTROL menu cycle.



NOTE: The charger's operation is independent of the inverting function. With the inverting function OFF, the charger can be set to come on when AC is available, but the inverting function will stay off with AC disconnected.

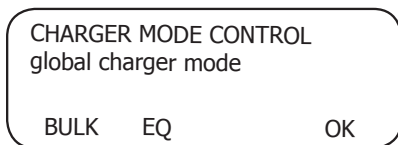

PRESS FOUR TIMES: (AC IN) (AC IN) (AC IN) (AC IN)

- The CHARGER MODE CONTROL screen appears, allowing the MATE to issue system (global) recharging commands.

Pressing <EQ> on the CHARGER MODE CONTROL screen brings up the EQUALIZE CONTROL screen

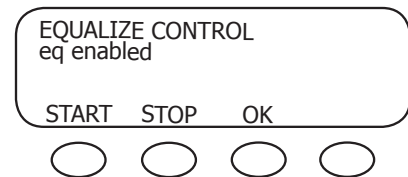

NOTE: EQ is not normally used with the OBX-IC2024S-120/60 Inverter.

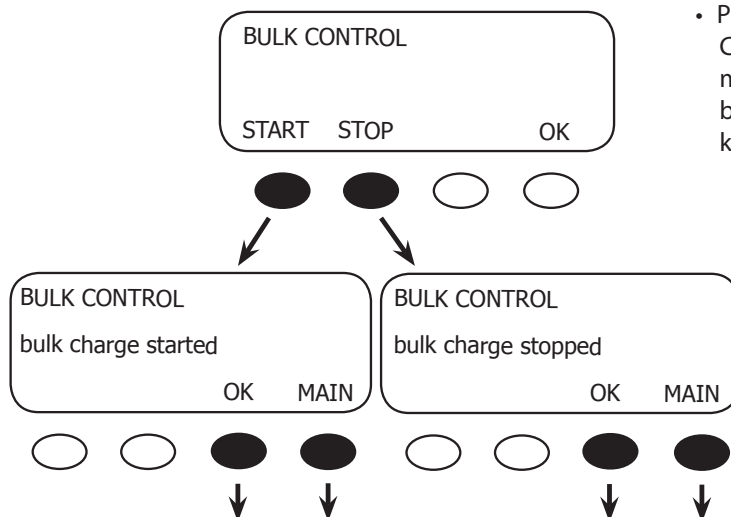

- Pressing <BULK> brings up the BULK CONTROL screen. This allows the user to manually start or stop a bulk charge cycle by pressing the <START> or <STOP> soft keys respectively.

- Once the <START> or <STOP> soft keys are pressed, the BULK CONTROL screen shows the status. The user can press <OK> to return to the CHARGER MODE CONTROL screen, or <MAIN> to return to the main MATE menu.

SOFT KEYS

“Soft” keys are the four buttons on the bottom of the MATE. Soft key functions vary with each menu. Menus with options have those options displayed along the bottom of the screen. When they are displayed, pressing a soft key picks the option directly above that key. Also, to return to the Main screen from anywhere in the system, simultaneously press the two soft keys on the left.

The Main screen has soft keys for the Summary, Status, Setup and Advanced menus. The Summary screens are shown below. The Setup menus are described starting on the next page. The Status screens are described starting on page 25. (Advanced menus are not normally required with the OBX-IC2024S-120/60 Inverter, and are not in this book.)

SUMMARY SCREENS

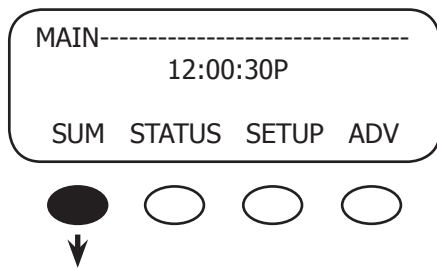
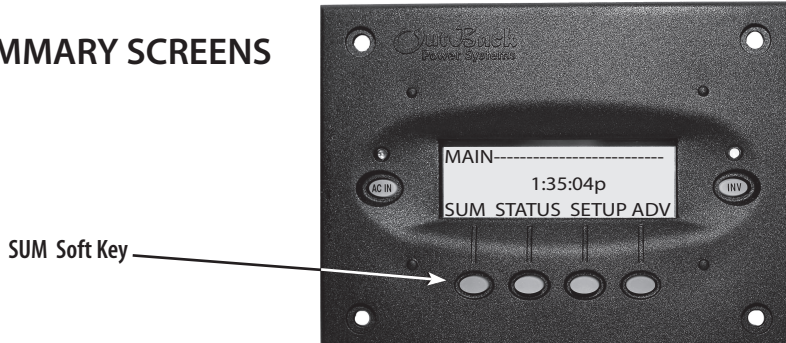

The Summary screens provided by the MATE:

- Combine information from the Status menus (see page 25) into a concise, easily accessible display.
- Summarize the current status of any Inverter connected to it.
- Can be set to pop up like a screen saver after a delay. (See Summary Setup Screens on page 21 for more setup information.)
- Any MATE soft key pressed while the Summary screen is being displayed returns the user to the screen that was active before the Summary screen was displayed. Pressing the two lower left soft keys at the same time opens the MAIN Menu screen.

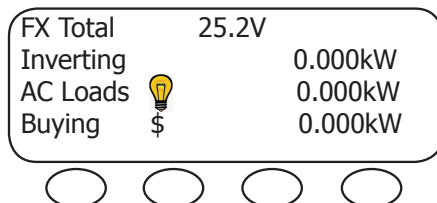

The user can press the <SUM> soft key to display the Summary screen.

The Inverter summary screen’s values summarize power flow in an Inverter system.

- The top line displays the battery voltage.
- The second line displays the operating status (typically “Inverting” if there is no AC source, or “Absorbing” or “Float” if the battery charger is on.) It also shows the kilowatts consumed by either the inverter or charger.
- The third line shows how many kilowatts are being consumed by the AC loads, whether the system is inverting or connected to an AC source.
- The last line shows how many kilowatts are being consumed from the AC source, if present. This number reflects the consumption of both the AC loads and the charger, and the status will read “Buying.” If there is no AC source, the status will read “No ACIN” and the number will be zero.

SETUP SCREENS

The Setup screens allow you to change several settings, to make your system run more smoothly. You can program the amperage size of the AC source, to keep the Inverter from overdrawing a generator. You can program the Summary screen to pop up automatically like a computer screensaver. In advanced systems, you can order the MATE to search for any new devices, in case it has lost communication with the Inverter.

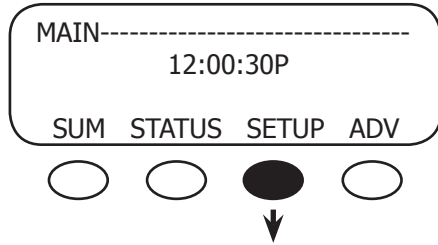

To program the size of an AC source, press the <SETUP> soft key from the **MAIN** screen.

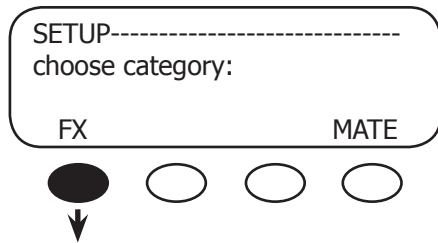

Press the <FX> soft key to enter the series of menus for Inverter options (referred to here as FX options).

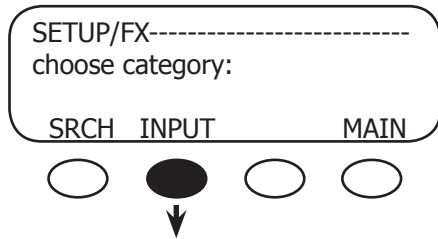

From the **SETUP/FX** screen, press the <INPUT> soft key. (The SRCH option is not normally required to be used with the OBX-IC2024S-120/60 Inverter.)

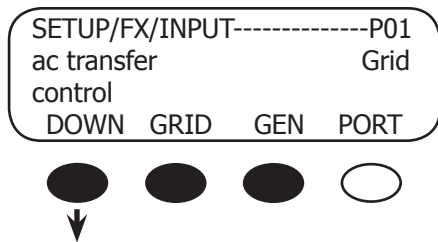

From the **SETUP/FX/INPUT** screen, you can tell which of two source sizes the Inverter should use. (The next items allow you to set the sizes.) To use grid (utility) power for a certain size, press the <GRID> soft key. To select a generator, press the <GEN> soft key. (The <PORT> soft key is only used if there are multiple Inverters.)

When finished, press the <DOWN> soft key.

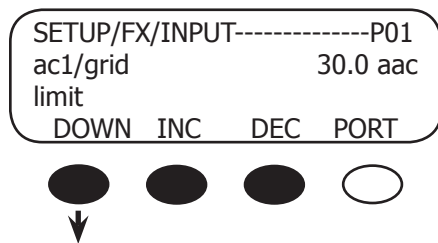

To select a grid source of a certain size, press either the <INC> or <DEC> soft keys as appropriate until the value reaches the correct number. When finished, or if you want to set the generator value instead, press the <DOWN> soft key.

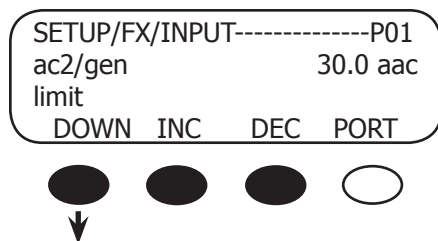

To select a generator of a certain size, press either the <INC> or <DEC> soft keys as appropriate until the value reaches the correct number. When finished, press the <DOWN> soft key. The next menu will allow you to either return to the top, return to the setup menu, or return to the Main screen.

SUMMARY SETUP SCREENS

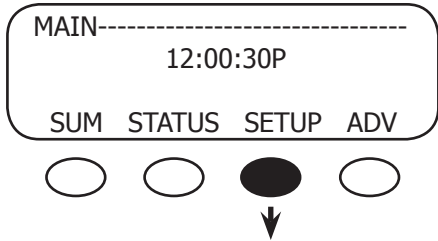

To program the operation of the **SUMMARY** screen, press the **<SETUP>** soft key from the **MAIN** screen.

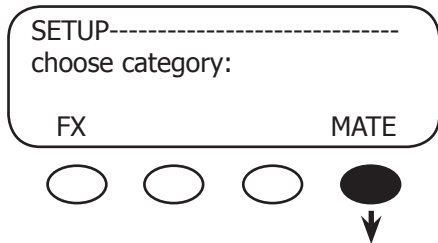

Press the **<MATE>** soft key to enter the series of menus for MATE setup and display.

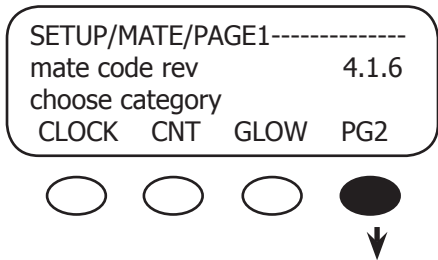

From the **SETUP/MATE/PAGE1** screen, press the **<PG2>** soft key. The other items on PAGE1 do not normally need to be adjusted.

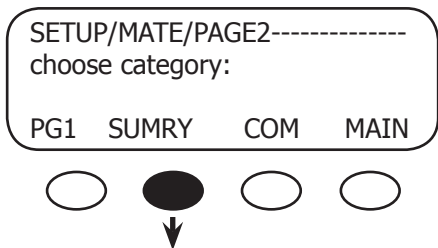

From the **SETUP/MATE/PAGE2** Setup choices screen, press the **<SUMRY>** soft key.

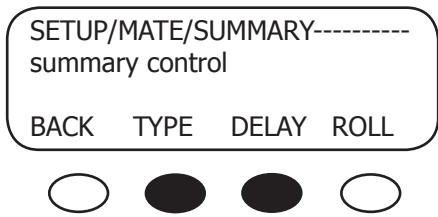

Pressing the **<SUMRY>** soft key brings up the screen **SETUP/MATE/SUMMARY** (summary control) and the screen options **<TYPE>**, **<DELAY>** and **<ROLL>**.

To select the automated SUMMARY screen, see below.

To select the delay timing of the automated **SUMMARY** screen, see the next page.

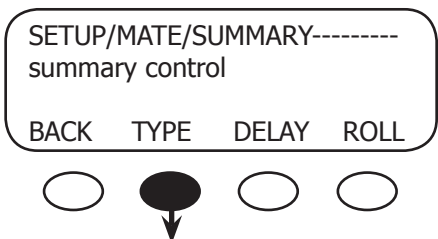

To choose the **SUMMARY** screen you want to view automatically and also view from the MAIN menu, press the **<TYPE>** soft key on the **SETUP/MATE/SUMMARY** screen.

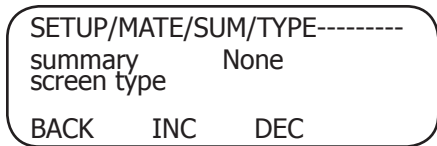

Press either the <INC> and <DEC> soft keys to change the **SUMMARY** screen to one of the following items:

None — disables the **SUMMARY** screen from automatically opening; the **SUMMARY** screen can still be accessed via the <SUM> soft key on the MAIN screen.

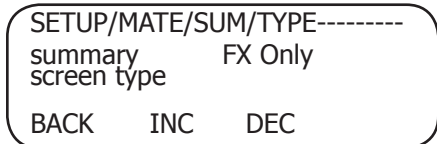

FX Only—the **SUMMARY** screen for the Inverter is enabled and will open after a delay time (see below).

Continuing to press either the <INC> or <DEC> soft keys will bring up other summary screen options.



NOTE: Other options in this menu are not normally used with the OBX-IC2024S-120/60 Inverter.

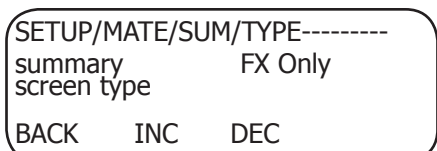

Press the <BACK> soft key to return to the **Summary Control** screen.

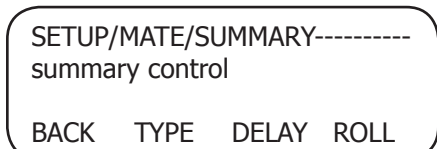

The <DELAY> soft key sets the time delay for the **SUMMARY** screen to appear. (See below and the next page.)

The <ROLL> soft key is not normally used with the OBX-IC2024S-120/60 Inverter.

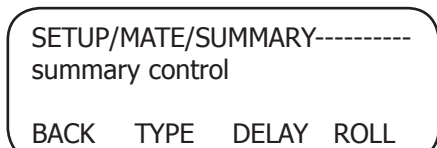

After selecting FX Only and exiting the **SETUP/MATE/SUM/TYPE** screen, the **SUMMARY** screen will automatically appear whenever the MATE has been inactive for the <DELAY> set point (very much like a screensaver on a computer monitor).

If “None” was selected, the MATE continues to display the last active screen viewed; if you press the <SUM> soft key on the MAIN menu when “None” is chosen, the **FX SUMMARY** screen appears.

To change the delay time:

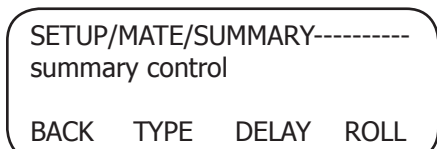

In the **SETUP/MATE/SUMMARY** screen, press the <DELAY> soft key; this will take you to sum screen delay time.

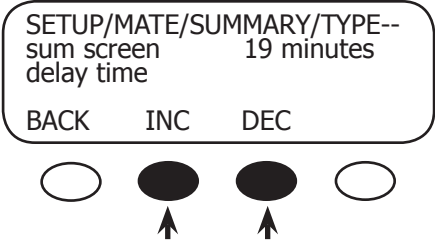

Sum screen delay time in **SUMMARY** mode shows how long it takes for a **SUMMARY** screen to be automatically displayed. This time can be increased or decreased by pressing the **<INC>** and **<DEC>** soft keys.

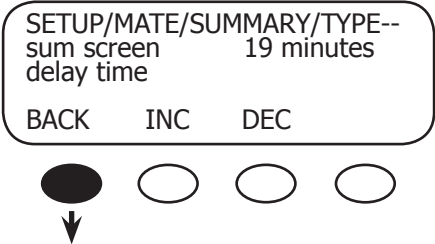

After the **SUMMARY** screen delay time is chosen, press the **<BACK>** soft key to return you to the summary control screen.

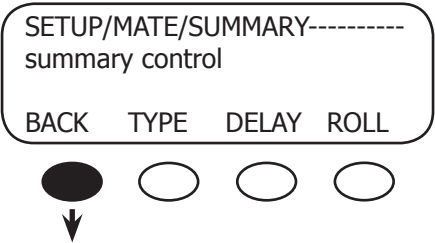

Return to the MAIN menu by pressing the **<BACK>** soft key to return to **SETUP/MATE/PAGE2**, and then pressing the **<MAIN>** soft key.

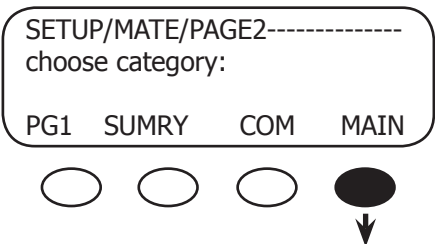

COMMUNICATION SETUP SCREENS

This part of Setup assists in communication between the Inverter and MATE. The MATE communicates commands to different components. If a HUB is present, it needs to be able to recognize any newly added or moved devices. (The Inverter is normally the only component connected to the HUB, but multiple components are possible.)

A comm error doesn't mean the system is failing, but that the MATE is looking for a component that has been moved from one HUB Port to another or has been disconnected completely. The MATE is trying to account for the system components.

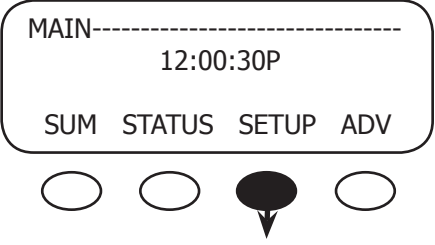

Any time you switch devices from one port to another, or any time you get a comm error, follow these steps:

To reach the COMM screen, press the **<SETUP>** soft key from the Main screen.



NOTE: Disconnecting and then reconnecting the MATE's CAT5 cable it will perform the same task, but the cable can be hard to remove from a mounted MATE.

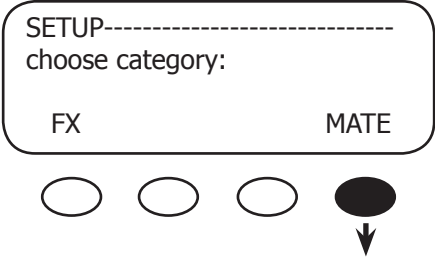

Press the **MATE** soft key to enter the series of menus for MATE setup and display.

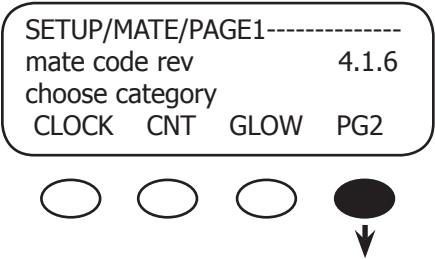

From the **SETUP/MATE/PAGE1** screen, press the **<PG2>** soft key.

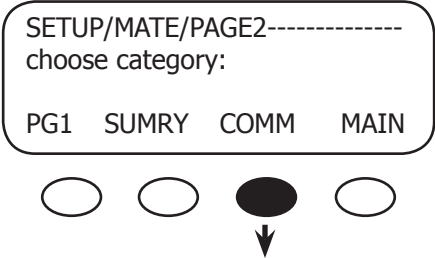

From the **SETUP/MATE/PAGE2** screen, press the **<COMM>** soft key.

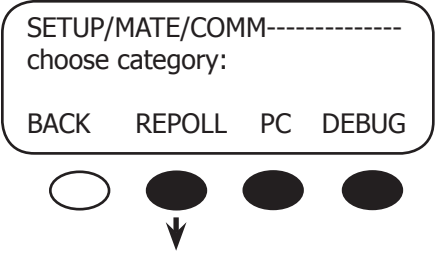

- **<RE POLL>** forces the MATE to “rediscover” all the OutBack devices it is connected to. This must be used any time an OutBack device is moved or added to a HUB.
- **<PC>** and **<DEBUG>** are not normally used with the OBX-IC2024S-120/60 Inverter.

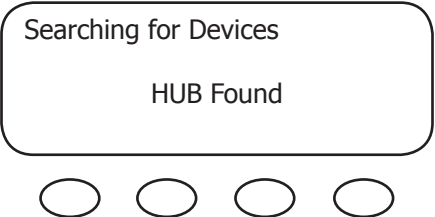

The MATE has found the HUB and will automatically go to the Port Assignment screen.

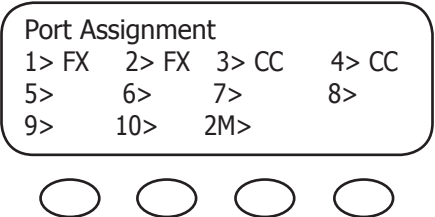

The Port Assignment screen will show which ports are occupied by an Inverter (represented by the initials “FX”). The Port assignment screen always shows 11 ports, even if the HUB has only 4 or 5.

After displaying the devices connected to each Port, the MATE returns to the choose category screen on its own.

STATUS SCREENS

Status screens give the user a breakdown of individual activities of the Inverter, including AC and DC voltage and AC current meters. It is these individual readings that combine to produce the Summary screens noted on page 19 and allow monitoring of the system operation.

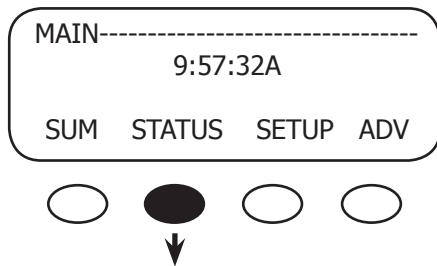
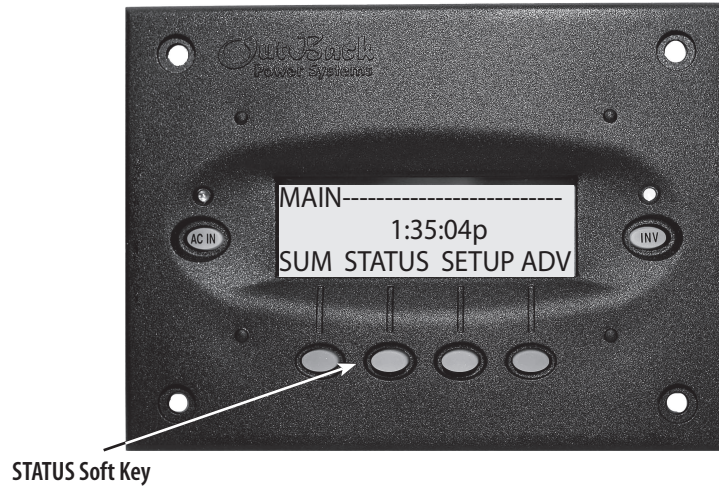

Press <**STATUS**> on the Main menu to access the **STATUS** menu. **STATUS** contains all the meters and mode displays for OutBack products connected to the MATE.

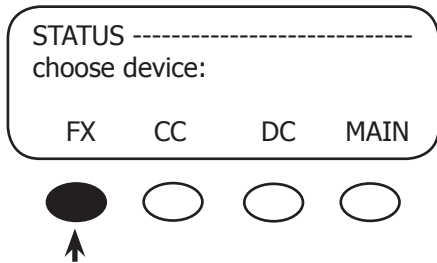

The **STATUS** menu is divided first by product and then into menu categories, such as meter, modes, and statuses. The <**FX**> soft key is used to access the Inverter's status menus.



NOTE: Not all STATUS screens are applicable to the Inverter. The screens differ by product type and revision. The <CC> and <DC> screens are not normally used with the Inverter.

Reading a Status Screen

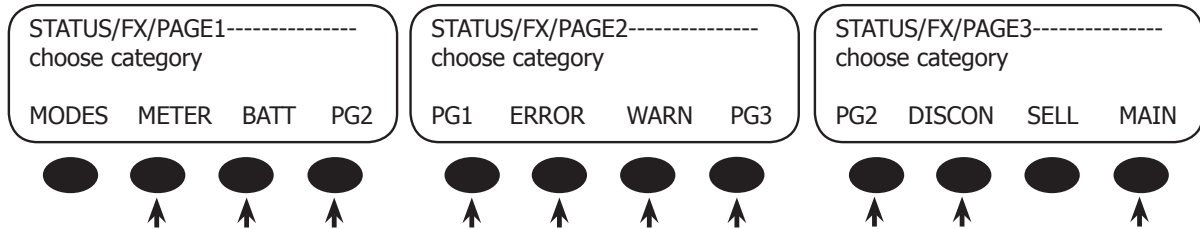

- *MODES*: not recommended for use with the OBX-IC2024S-120/60 Inverter -- do not select this option
- *METER*: displays inverter and charger activity, including output and input AC voltage, and AC inverter, charger, and input current
- *BATT*: displays the battery temperature, voltage and the various set points for the different recharging cycles as well as the time remaining to complete any of those cycles
- *PG2*: pressing the <PG2> soft key opens the next selection of **STATUS** screens

- *ERROR*: various errors and their causes, some external and some internal to the Inverter; an error can shut the unit down
- *WARN(ING)*: various warning situations, some external and some internal to the Inverter; warnings will not shut the unit down
- *PG3*: Pressing the <PG3> soft key opens the last **STATUS** screen

- *DISCON*: lists the reasons the Inverter disconnects from an AC source
- *SELL*: not used with the OBX-IC2024S-120/60 Inverter -- do not select this option
- *MAIN*: exits **STATUS** and returns to the Main menu

Status Meter Screens

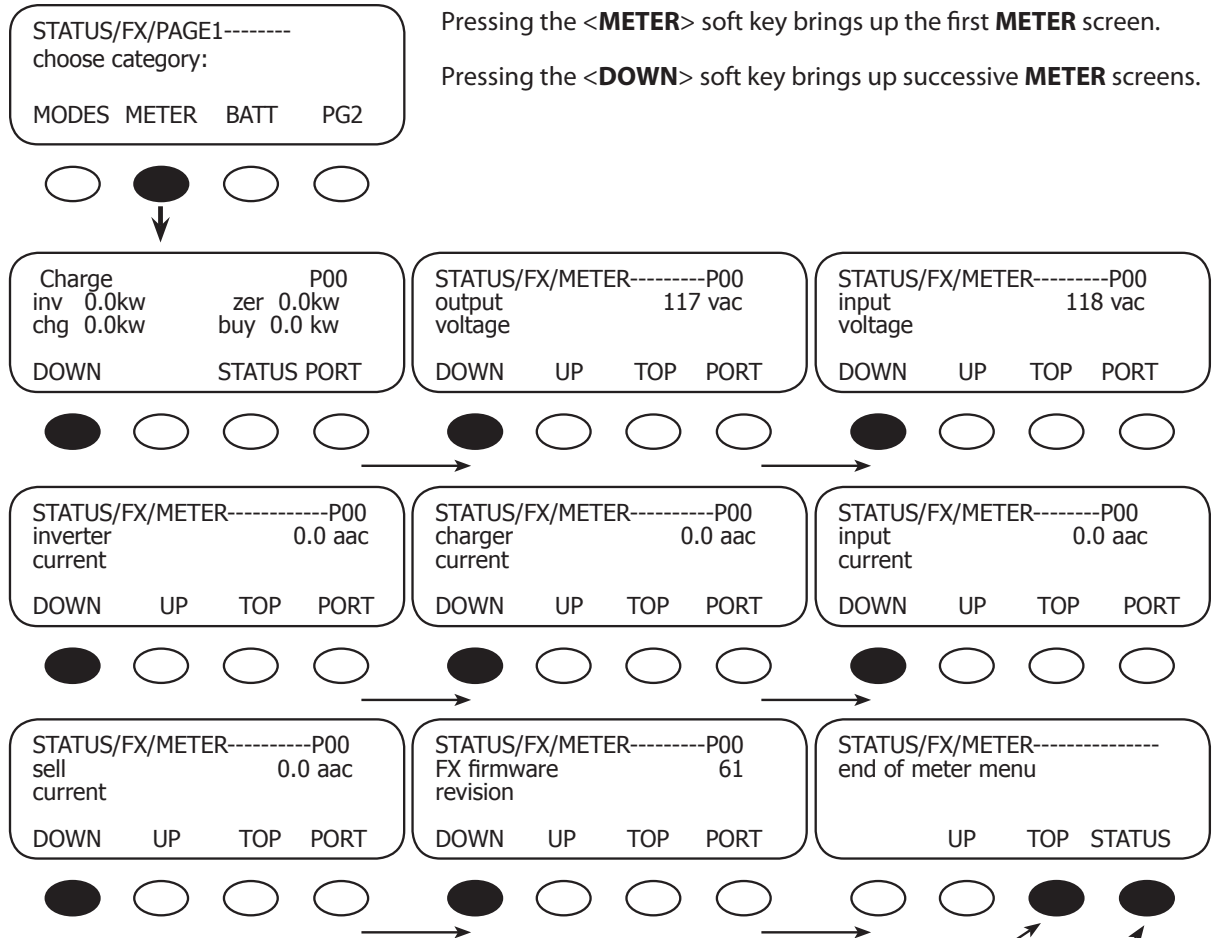

METER Screens

The **METER** screens displays current, voltage and wattage measurements, Inverter status, and the version of Inverter software, in this order:

- initial screen, beginning with **charge/invert/float/etc**:
 - shows the unit’s operating mode (see table to the right)
 - *inv*: kilowatts being taken from the batteries while inverting.
 - *chg*: kilowatts being put into the batteries while charging.
 - *zer*: not active in this model
 - *buy*: total kilowatts drawn from AC source (charge and loads)
- output voltage*: available AC voltage at the Inverter’s AC output
- input voltage*: available AC voltage at the Inverter’s AC input, from utility or generator
- inverter current*: AC amperage being drawn by loads on AC output when Inverter is ON and no AC source is connected
- charger current*: AC amperage used by the Inverter’s charger
- input current*: AC amperage drawn by the Inverter’s AC input (combination of charging and loads)
- sell current*: not active in this model
- FX firmware*: current Inverter software version

The **METER** values cannot be changed in the **STATUS** screens.

Push <TOP> to return to the first **METER** screen.

Push <STATUS> to return to the “choose category” **STATUS** screen.

The first METER screen shows what the Inverter is doing at the time this screen is viewed. The list below shows the possible activities and what they mean.

Activity	Definition
Off	Inverter turned off; no AC source
Search	Inverter on but asleep; no load demand
On	Inverting from batteries; no AC source
Charge	Charging batteries from AC source
Silent	Using AC source, charging complete
Float	Maintaining batteries once full
EQ	Running controlled battery overcharge
Chr Off	Using AC source; charger turned off

Status Error Screens

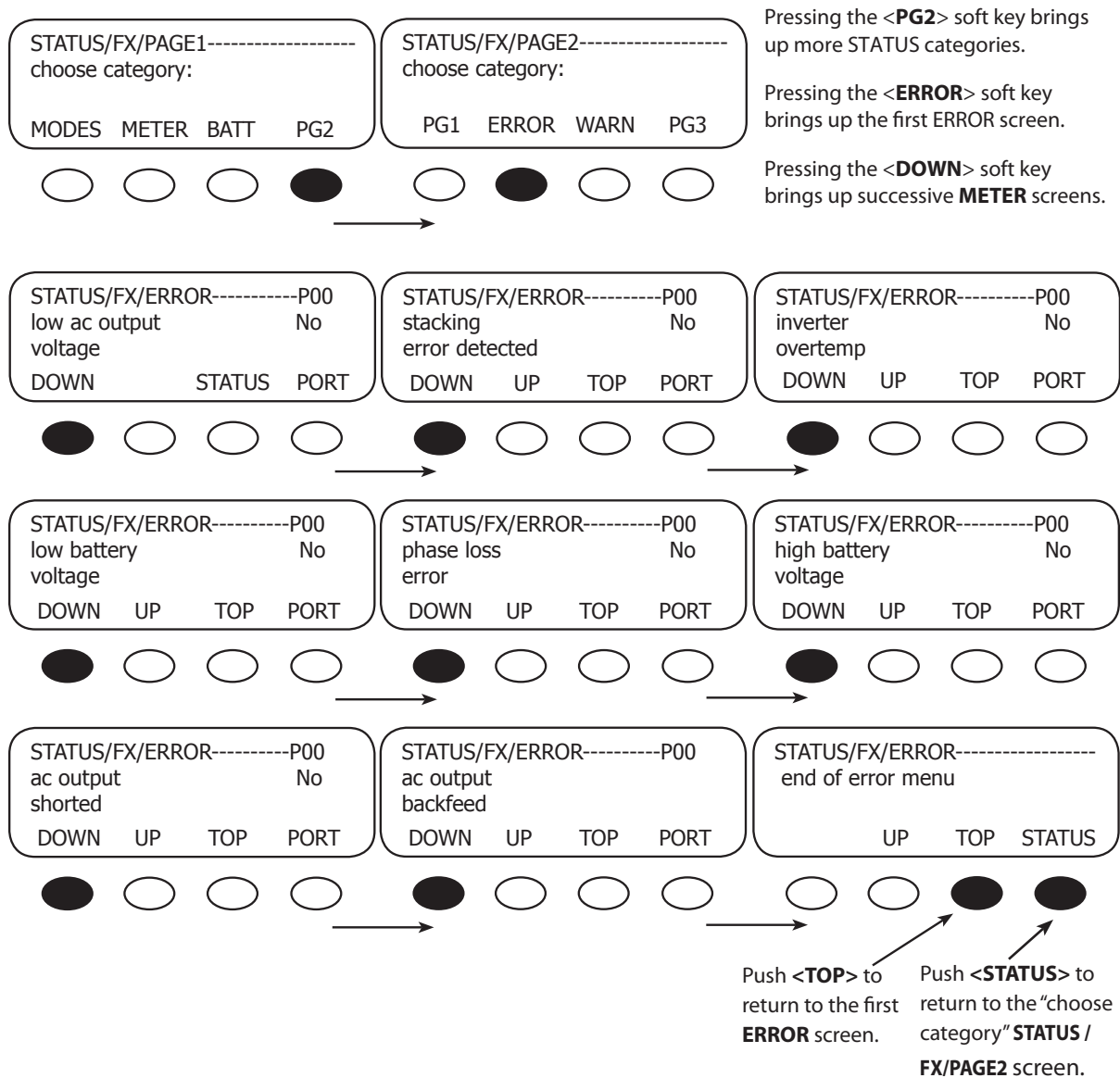

ERROR Screens

All screens read status as "No" under normal conditions. If the unit shuts off due to a specified error condition, that screen will change to "Yes".

- *low ac output voltage*: load too high; Inverter could not supply enough AC voltage to meet demand
- *stacking error detected*: communication problem among stacked units
- *inverter overtemp*: Inverter has reached its maximum allowed operating temperature
- *low battery voltage*: battery voltage is below the LOW BATTERY CUT-OUT VOLTAGE set point (This error can be triggered by other events. It can trigger with low AC output or AC shorted.)
- *phase loss error*: not active in the OBX-IC2024S-120/60 Inverter
- *high battery voltage*: battery voltage rose above the safe high battery voltage level for 10 seconds
- *ac output shorted*: Inverter reached its maximum current and shut down
- *ac output backfeed*: usually indicates another AC power source was connected to the Inverter's AC output

These are hard faults. The Inverter must be turned off and then on to reset. ERROR screens can only display errors; they do not offer any means to correct them. Generally the nature of the error suggests how to correct it.

Status Warn(ing) Screens

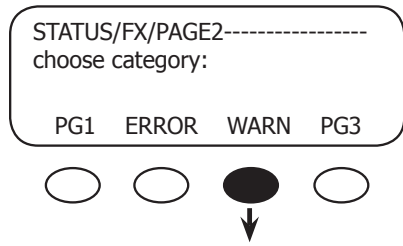

Pressing the <WARN> soft key brings up the first WARN screen.

Pressing the <DOWN> soft key brings up successive WARN screens.

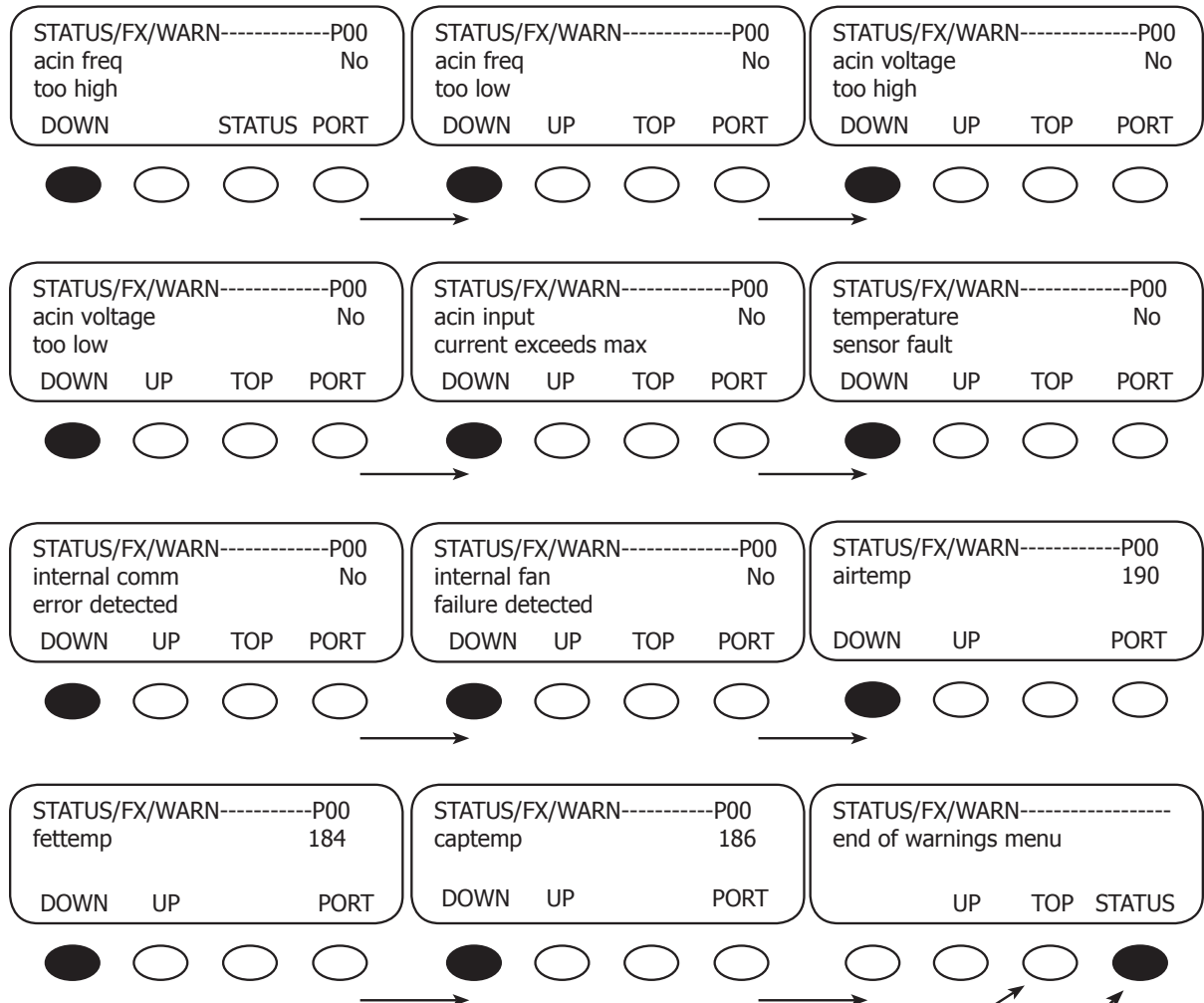

Push <TOP> to return to the first **WARNING** screen.

Push <STATUS> to return to the "choose category" **STATUS /FX/ PAGE2** screen.

WARN(ING) Screens

All warning screens read status as "No" under normal conditions. If the appropriate condition is met, that screen will change to "Yes."

- *acin freq too high*: AC source is above 66 Hz (upper limit) and will be dropped
- *acin freq too low*: AC source is under 54 Hz (lower limit) and will be dropped
- *acin voltage too high*: AC source's voltage is over 140 Vac (default limit) and will be dropped
- *acin voltage too low*: AC source's voltage is under 108 Vac (default limit) and will be dropped
- *acin input current exceeds max*: AC loads are drawing more current than the rating of the FX allows
- *temperature sensor fault*: an internal FX temperature sensor is malfunctioning
- *internal comm error detected*: there is a communication problem between MATE and Inverter (see p. 23)
- *internal fan failure detected*: the Inverter's internal cooling fan is not operating properly

The following items are not warnings, but are data readings related to the temp sensor warning

- *airtemp*: displays a numeric value representing the air temperature around the Inverter
- *fettemp*: displays a numeric value representing the temperature of the FETs (Field Effect Transistors)
- *captemp*: displays a numeric value representing the temperature of the ripple capacitors

(These values are used for troubleshooting purposes. The higher the numerical value, the cooler the temperature.)

Status Discon(nect) Screens

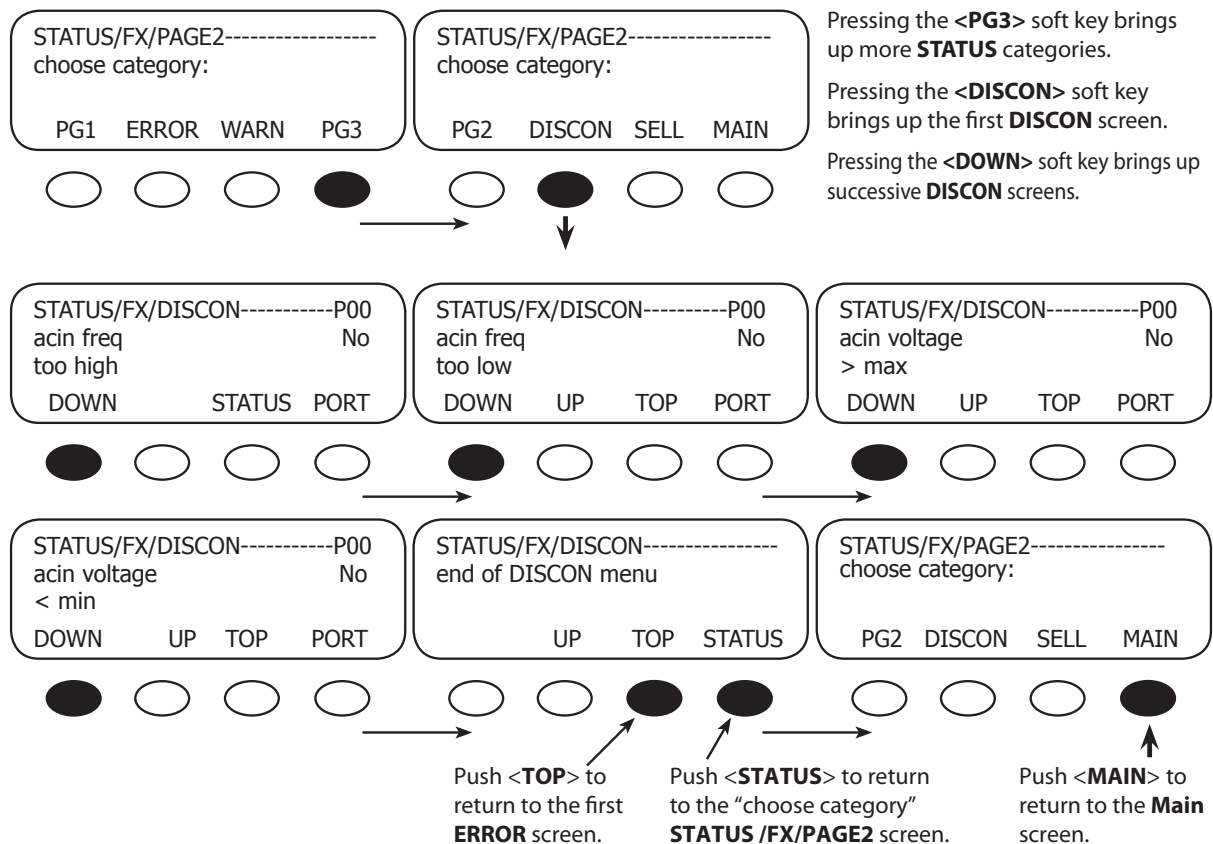

DISCON(NECT) Screens

- *acin freq too high*: displays "Yes" if the AC source exceeds 66 Hz and the Inverter disconnects from the source
- *acin freq too low*: displays "Yes" if the Inverter disconnects from an AC source below 54 Hz
- *acin voltage > max*: the source of the AC voltage exceeds the Inverter maximum of 140 Vac
- *acin voltage < min*: the source of the AC voltage falls below the Inverter minimum of 108 Vac

INSTALLATION DRAWING

- A 30A input breaker (maximum) must be used with the AC source
- A 30A breaker (maximum) must be used to protect the output circuit
- A single Inverter can continuously power up to 2.0 kW of loads depending on the ambient temperature.

AC IN AND AC OUT COLOR CODE:
 WHITE = NEUTRAL
 BLACK = HOT
 GREEN = GROUND
 GREEN/YELLOW = NEUTRAL-GROUND BOND

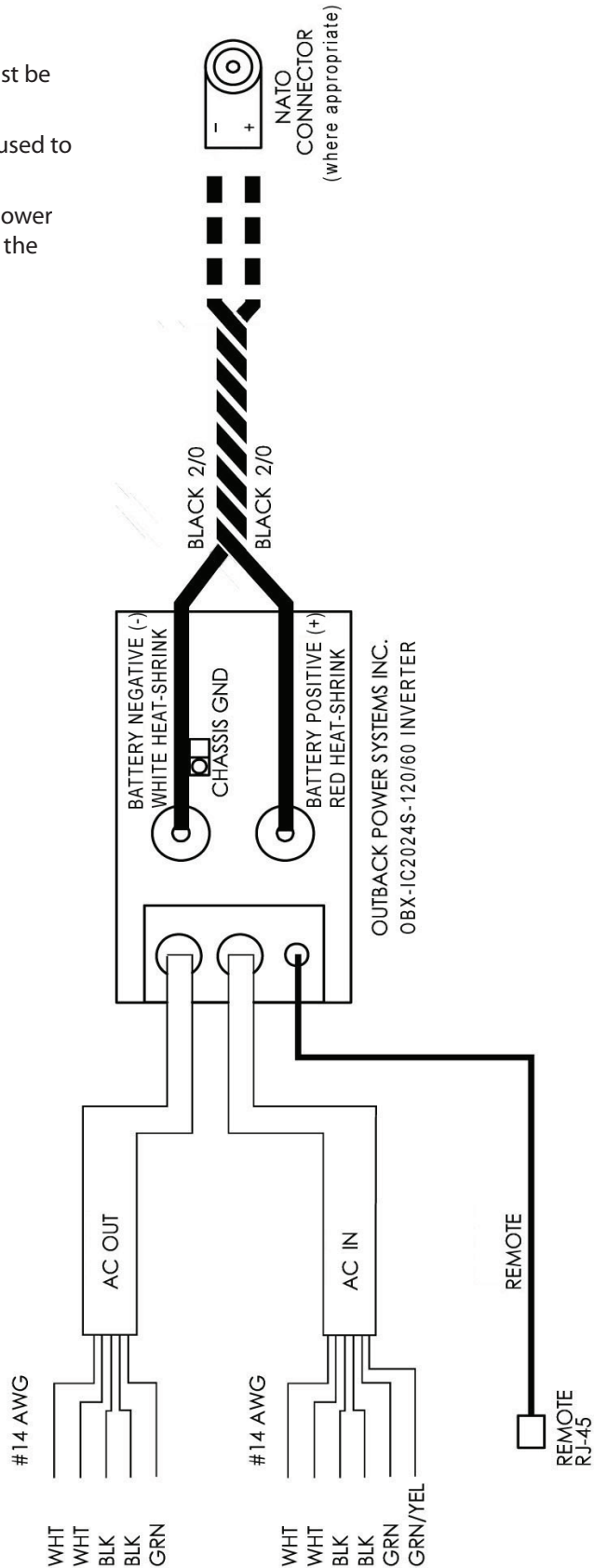

INSTALLATION CHECK LIST		
ITEM	YES	NO
Manual read and reviewed?		
System mounted with the recommended number and sized fasteners?		
System installed according to required codes and regulations?		
System inspected?		
System grounded?		
Inverter output connected to load circuit with 30 AC amp maximum overcurrent protection?		
Inverter AC sources protected with 30 AC amp maximum overcurrent protection?		
Per the instructions regarding neutral and ground installation on page 7,		
If the installation is non-bonded,		
▶ Inverter green/yellow wire connected?		
▶ Input and output neutral wires isolated from each other?		
▶ Generator's neutral and ground bonded together?		
OR		
If the installation is bonded,		
▶ Inverter green/yellow wire disconnected?		
▶ Input and output neutral wires on a common bus?		
▶ Generator's neutral and ground isolated from each other?		
All cables torqued to OutBack specifications?		
▶ Battery connections to 10 foot-lbs/13.55 Nm?		
▶ Inverter DC terminals to 5 foot-lbs/5.8 Nm?		
Inverter DC terminals and all exposed conductors coated in dielectric grease?		

OBX-IC2024S-120/60 Inverter/Charger Specifications

Nominal DC Input Voltage Range	24 Vdc
Nominal AC Voltage / Frequency	120 Vac / 60 Hz
Continuous Power Rating at 25°C Ambient	2000 VA
Continuous AC RMS Output at 25°C	16.7 Aac
Idle Power - Full AC Output	≈ 20 watts
Idle Power - Search Mode	6 watts
Typical Efficiency	92%
Total Harmonic Distortion - Typical	2%
Output Voltage Regulation	± 2%
Maximum Output Current – Peak (1 mSec)	70 Aac
Maximum Output Current - RMS (100 mSec)	50 Aac
AC Overload Capability - Surge	6000 VA
AC Overload Capability - 5 Second	4800 VA
AC Overload Capability - 30 Minutes	3200 VA
AC Input Current Maximum	30 Aac
AC Input Voltage Range	80 to 150 Vac
AC Input Frequency Range	54.0 to 66.0 Hz
DC Input Range	21.0 to 34.0 Vdc
DC Input Current – Rated Power	100 Adc
Maximum DC Input Surge Current	300 Adc
Continuous Battery Charger Output	55 Adc

Recommended DC Voltage Range

24V Systems	21 – 34 Vdc
-------------	-------------

Maximum DC Input Current

Note: This is the maximum DC current the Inverter will draw from the battery when starting very large AC loads. It is not used for sizing the DC disconnect or selecting DC cable gauge. It is used to select the minimum reasonable battery capacity.

OBX-IC2024S-120/60 Inverter	300 Adc
-----------------------------	---------

Rated DC Input Current

Note: This is the maximum continuous DC current that the Inverter will draw from the batteries when inverting.

OBX-IC2024S-120/60 Inverter	100 Adc
-----------------------------	---------

AC Input Operating Voltage Range

Note: This is the recommended AC input voltage range to be supplied to the Inverter. Voltages outside of this range will not be accepted by the Inverter.

OBX-IC2024S-120/60 Inverter	80 – 150 Vac (Vac = volts AC)
-----------------------------	-------------------------------

AC Input Frequency Range

Note: If the AC input source is out of the range noted below, the Inverter will not connect or stay connected.

OBX-IC2024S-120/60 Inverter	54-66 Hz
-----------------------------	----------

Maximum AC Input Current

An AC input source connected to the Inverter supplies power for two separate internal AC circuits – the AC transfer switch and the battery charging system. The AC transfer switch transfers the AC input power to the AC loads. The Inverter’s battery charger will “back off” if the total AC loads—including the charger—exceed the AC input current limit (default setting is 30 Aac). This “Input Limit” can be adjusted using the MATE to avoid overloading a generator or trip a circuit breaker. If your generator cannot produce 30 Aac or you are connecting to an AC input source that has a breaker that is rated for less than 30 Aac, please refer to page 20 to change this setting.

OBX-IC2024S-120/60 Inverter	30 Aac (Aac = Amps AC)
-----------------------------	------------------------

Maximum Current For Battery Charger (bulk stage)

OBX-IC2024S-120/60 Inverter	AC Max = 14 Aac (Default = 12 Aac)	DC Max = 55 Adc
-----------------------------	------------------------------------	-----------------

Maximum AC Output Current

This is the amount of surge current that the Inverter will quickly supply for a split second. Depending on the size of the surge, the Inverter can be overloaded for a minimum time of 5 seconds to a maximum time of 30 minutes.

OBX-IC2024S-120/60 Inverter	70 Aac for 1 millisecond
-----------------------------	--------------------------

Maximum Overcurrent Protection Ampacity

This rating specifies the proper overcurrent protection ampacity.

- Bolt-in type class T DC fuses and should always be used in conjuncture with a disconnect mechanism.
- Inverters used in fixed installations should use properly sized DC circuit breakers.
- A DC breaker includes both overcurrent protection and disconnect capability.
- OutBack Power Systems recommends Class T fuses for mobile installations where a DC disconnect is not required.

Model	Ampacity	DC Breaker	DC Fuse
OBX-IC2024S-120/60 Inverter	175 Adc	OBB-175-125VCD-PNL	Class T-300

INVERTER DEFAULT VALUES (subject to change with upgrades)

24 VDC System	DEFAULT	MINIMUM	MAXIMUM
Float Voltage	27.4 Vdc	24 Vdc	30 Vdc
Absorb Voltage	29.4 Vdc	26 Vdc	32 Vdc
EQ Voltage	28.8 V	28 Vdc	34 Vdc
ReFloat	25 Vdc	22 Vdc	26 Vdc
LBCO	21 Vdc	18 Vdc	24 Vdc
Absorb Time	2.0 hours	0.0 hours	24.0 hours
EQ Time	1.0 hours	0.0 hours	24.0 hours
Float Time	1.0 hours	0.0 hours	24.0 hours
Charger Draw	5 Aac	0 Aac	7 Aac
AC1/Grid Transfer Delay	6 AC cycles	0 AC cycles	240 AC cycles
AC2/Gen Transfer Delay	60 AC cycles	0 AC cycles	240 AC cycles
Grid Lower Limit	108 Vac	40 Vac	115 Vac
Grid Upper Limit	140 Vac	130 Vac	150 Vac
Grid Connect Delay	0.5 min	0.2 min	15.0 min
Gen Lower Limit	108 Vac	40 Vac	115 Vac
Gen Upper Limit	140 Vac	130 Vac	150 Vac
AC DROP or USE	USE	N/A	N/A
Charger OFF/AUTO/ON	AUTO	N/A	N/A
Search Threshold	6 watts	0 watts	50 watts
Search Pulses	8	2	20
Search Pulse Spacing	60 AC cycles	4 AC cycles	120 AC cycles
Stacking Phase	1 or 2 phase	N/A	N/A
InPut Select	Gen	N/A	N/A
Grid Input Settings	28 Aac	5 Aac	30 Aac
Gen Input Settings	28 Aac	2 Aac	30 Aac
Set Output Voltage	120 Vac	115 Vac	125 Vac

Maintenance

- Following exposure to salt water, rinse all exposed surfaces to prevent corrosion. Recoat the DC lugs and other exposed conductors with dielectric grease.
- Periodically check that the battery cable lugs are tight and secure according to the recommended torque settings on page 8.
- Brush off excessive dust from the Inverter as needed.
- Check that fasteners securing the Inverter to its mounting surface are tight.
- Check that the screws securing the DC Cover to the Inverter are tight.

Troubleshooting

If the Inverter is not operating:

- Use a meter to verify the DC battery voltage at the Inverter terminals.
- Measure and verify the AC current at the Inverter output terminals.
- Swap the MATE or its cable with another, in case the MATE is interfering with Inverter operation.
- Check the Error screens as described on pages 26 and 29, for any messages that say “Yes”. If a “Yes” message appears, you will need to investigate the circumstances as appropriate.

If the Inverter operates but the MATE does not work (or gives you incorrect information):

- Swap the MATE or its cable for another. If they work, this may tell you which of the two has a problem.
- Test the original MATE or its cable on a different Inverter installation. If they work, the problem is in the original Inverter.
- Check the Warning screens as described on pages 26, 30 and 31, for an “internal comm error”. If this message is present, follow the instructions for Communications setup on pages 23 and 24.

If the Inverter operates but will not connect or charge from an AC source (or if operation is unreliable)

- Check the Warning screens as described on pages 26, 30 and 31, for any messages that say “Yes”. If a “Yes” message appears, you will need to investigate the circumstances as appropriate.

If nothing else works:

- Call OutBack Technical Support for further assistance or repairs. Being heavily sealed, the Inverter is not user-serviceable.

OutBack Technical Support is reachable at (360) 618-4363 or support@outbackpower.com.

(Please see the warranty section of this manual for more service information.)



1-Year Limited Warranty

OutBack Extreme Inverter/Chargers

OutBack Power Systems, Inc. ("OutBack") provides a one year (1) limited warranty ("Warranty") against defects in materials and workmanship for its OutBack Extreme Inverter/Charger ("Product") if installed in a permanently mounted installation. The Warranty term begins ninety (90) days from the date of initial invoice.

This Warranty applies to the original OutBack Product purchaser, and is transferable only if the Product remains installed in the original use location. The warranty does not apply to any Product or Product part that has been modified or damaged by the following:

- Installation or Removal;
- Alteration or Disassembly;
- Normal Wear and Tear;
- Accident or Abuse;
- Corrosion;
- Lightning;
- Repair or service provided by an unauthorized repair facility;
- Operation or installation contrary to manufacturer product instructions;
- Fire, Floods or Acts of God;
- Shipping or Transportation;
- Incidental or consequential damage caused by other components of the power system;
- Any product whose serial number has been altered, defaced or removed; or
- Any other event not foreseeable by OutBack.

OutBack's liability for any defective Product, or any Product part, shall be limited to the repair or replacement of the Product, at OutBack's discretion. OutBack does not warrant or guarantee workmanship performed by any person or firm installing its Products. This Warranty does not cover the costs of installation, removal, shipping (except as described below), or reinstallation of Products.

To request warranty service, you must contact OutBack Technical Services at (360) 618-4363 or support@outbackpower.com within the effective warranty period. If warranty service is required, OutBack will issue a Return Material Authorization (RMA) number. A request for an RMA number requires all of the following information:

1. Proof-of-purchase in the form of a copy of the original Product purchase invoice or receipt confirming the Product model number and serial number;
2. Description of the problem; and
3. Shipping address for the repaired or replacement equipment.

After receiving the RMA number, pack the Product(s) authorized for return, along with a copy of the original purchase invoice and warranty certificate, in the original Product shipping container(s) or packaging providing equivalent protection and mark the outside clearly with the RMA number. The sender must prepay all shipping charges, and insure the shipment, or accept the risk of loss or damage during shipment. OutBack is not responsible for shipping damage caused by improperly packaged Products, the repairs this damage might require, or the costs of these repairs. If, upon receipt of the Product, OutBack determines the Product is defective and that the defect is covered under the terms of this Warranty, OutBack will then and only then ship a repaired or replacement Product to the purchaser freight prepaid, non-expedited, using a carrier of OutBack's choice within the continental United States, where applicable.

Shipments to other locations will be made freight collect. The warranty period of any repaired or replacement Product is ninety (90) days from the date of shipment from OutBack, or the remainder of the initial warranty term, whichever is greater.

THIS LIMITED WARRANTY IS THE EXCLUSIVE WARRANTY APPLICABLE TO OUTBACK PRODUCTS. OUTBACK EXPRESSLY DISCLAIMS ANY OTHER EXPRESS OR IMPLIED WARRANTIES OF ITS PRODUCTS, INCLUDING BUT NOT LIMITED TO ANY IMPLIED WARRANTIES OF MERCHANTABILITY OR FITNESS FOR A PARTICULAR PURPOSE. OUTBACK ALSO EXPRESSLY LIMITS ITS LIABILITY IN THE EVENT OF A PRODUCT DEFECT TO REPAIR OR REPLACEMENT IN ACCORDANCE WITH THE TERMS OF THIS LIMITED WARRANTY AND EXCLUDES ALL LIABILITY FOR INCIDENTAL OR CONSEQUENTIAL DAMAGES, INCLUDING WITHOUT LIMITATION ANY LIABILITY FOR PRODUCTS NOT BEING AVAILABLE FOR USE OR LOST REVENUES OR PROFITS, EVEN IF IT IS MADE AWARE OF SUCH POTENTIAL DAMAGES. SOME STATES (OR JURISDICTIONS) MAY NOT ALLOW THE EXCLUSION OR LIMITATION OF WARRANTIES OR DAMAGES, SO THE ABOVE EXCLUSIONS OR LIMITATIONS MAY NOT APPLY TO YOU.



OUTBACK EXTREME INVERTER/CHARGER LIMITED WARRANTY REGISTRATION

Complete this form and return it to:

OutBack Power Systems Inc.
19009 62nd Ave. NE • Arlington, WA 98223

EXTREME LIMITED WARRANTY REGISTRATION

Equipment Owner:

Name/Rank: _____

Organization/Branch of Service: _____

Address: _____ City, State, Zip Code: _____

Country: _____ Telephone Number: _____

E-mail: _____

Address for warranty certificate:

Name/Rank: _____

Organization/Branch of Service: _____

Address: _____ City, State, Zip Code: _____

Country: _____ Telephone Number: _____

E-mail: _____

Product Model Number: _____ Product Serial Number(s): _____

Sold by: _____ Purchase Date: _____

Product Install/Commission Date: _____ System PV Array Nominal Voltage: _____

System Battery Bank Size (Amp Hours): _____ Type of Batteries: _____

General Description of Application: _____



Corporate Headquarters
19009 62nd Avenue NE
Arlington, WA 98223 USA
Phone: (+1) 360.435.6030

European Sales Office

Barcelona, España
Phone: +34.93.654.9568

www.outbackpower.com

900-0046-01-00 REV A